

Owner's Manual

INCLUDES

User, Maintenance, Service, and Installation
Instructions

INFINITY

780 BF NG



Keep this booklet for service log and future reference

IMPORTANT



This appliance is guaranteed for 12 months subject to conditions. The 5 year extended parts warranty will only be valid if the annual service recommended in this manual has been completed and appliance has been registered online.

Contents

EXTENDED FIVE YEAR PARTS WARRANTY	2
Benchmark Scheme	3
SECTION ONE Important Information (users instructions).....	5
SECTION TWO Introduction (users instructions).....	7
SECTION THREE Operation (users instructions)	7
SECTION FOUR Cleaning & Laying the fuel bed (users instructions).....	11
SECTION FIVE Appliance Data (installation instructions).....	15
SECTION SIX Regulations and Warnings (installation instruction)	16
SECTION SEVEN Siting the Appliance (installation instructions).....	17
SECTION EIGHT Preparing the Appliance for Installation (installation instructions)	18
SECTION NINE CONNECTING THE GAS SUPPLY	22
SECTION TEN Assemble the appliance (installation instructions).....	24
SECTION ELEVEN Instruct and Advise the Customer (installation instructions)	25
SECTION TWELVE (Maintenance Instructions)	26
SECTION TWELVE Wiring Diagram (maintenance instructions).....	29
BALANCED FLUE GAS FIRE COMMISSIONING CHECKLIST	34
SERVICE RECORD.....	35



EXTENDED FIVE YEAR PARTS WARRANTY

In order to validate your extended 5 years parts warranty please read the Benchmark Scheme on the opposite page and ensure your installer has filled in the appropriate checklist.

This in no way reduces your statutory rights

Your warranty commences from the date of purchase and you must retain your receipt or invoice as proof of a purchase date.

THIS EXTENDED WARRANTY SPECIFICALLY EXCLUDES GLASS AND SOFT REFRACTORY COMPONENTS, THE BULB AND ANY BATTERIES.

Terms and Conditions

1. The appliance must be installed by a GAS SAFE registered person.
2. The appliance must be used in accordance with the user's instructions.
3. The appliance must be serviced annually by a GAS SAFE registered person.
4. The benchmark and service log must be correctly filled out and the record of annual services must be up to date and supported by receipts in each case.
5. This warranty is not transferable and relates to the original installation only.
6. The appliance has not been subjected to misuse or accident or been modified or repaired by any person other than the authorised employee or authorised representative of Charlton and Jenrick Ltd.
7. The registration form must be returned within 1 month of purchase.

Technical Help Desk 01952 200 444

Benchmark Scheme



Charlton and Jenrick Ltd is a licensed member of the Benchmark Scheme which aims to improve the standards of installation and commissioning of domestic heating and hot water systems in the UK and to encourage regular servicing to optimise safety, efficiency and performance. Benchmark is managed and promoted by the Heating and Hotwater Industry Council. For more information and the full code of practice please visit www.centralheating.co.uk

Please ensure that the installer has fully completed the Benchmark Checklist on the inside back pages of the installation instructions supplied with the product and that you have signed it to say that you have received a full and clear explanation of its operation. The installer is legally required to complete a commissioning checklist as a means of complying with the appropriate Building Regulations (England and Wales).

All installations must be notified to Local Area Building Control either directly or through a Competent Persons Scheme. A Building Regulations Compliance Certificate will then be issued to the customer who should, on receipt, write the Notification Number on the Benchmark Checklist.

This product should be serviced regularly to optimise its safety, efficiency and performance. The service engineer should complete the relevant Service Record on the Benchmark Checklist after each service.

The Benchmark Checklist will be required in the event of any warranty.

It is a requirement that the gas fire is installed and commissioned to the manufacturer's instructions and the data fields on the commissioning checklist completed in full.

To instigate the guarantee, the gas fire needs to be registered with the manufacturer within one month of the installation.

To maintain the guarantee, it is essential that the gas fire is serviced annually by a Gas Safe registered engineer. The service details should be recorded on the Benchmark Service Interval Record and left with the householder.

Important

For future reference we suggest you record the following details here, and keep the receipt as proof of purchase. This information may be asked for when you contact the helpdesk.

MODEL:	INFINITY 780 BF	Serial No.	
---------------	------------------------	-------------------	--

This information can be found on the label attached to the packaging and on the data badge, which is located on the base of the appliance behind the control cover.

Retailer Name:	
Address:	
Date Of Purchase:	

Installer information required to register for the extended warranty

Name:	
Date of installation:	
Gas safe number:	

SECTION ONE Important Information (users instructions)

Consumer protection information

As manufacturers and suppliers of heating products, we take every care, as far as is reasonably practicable, that these products are so designed and constructed as to meet the general safety requirement when properly used and installed. To this end, our products are thoroughly tested and examined before despatch.

IMPORTANT NOTICE: Any alteration that is not approved by the appliance manufacturer could invalidate the approval of the appliance, operation of the warranty and could affect your statutory rights.

Health and safety notice

Important

This appliance could contain some of the materials, indicated below, that could be interpreted as being injurious to health and safety. It is the users / installers responsibility to ensure that the necessary personal protective clothing is worn when handling these materials, see below for information.

Artificial Fuels, Mineral Wool, Insulation Material, Refractory/Ceramic Fibres, Glass Yarn - *may be harmful if inhaled, may be irritating to skin, eyes, nose and throat.*

When handling *avoid inhaling and contact with skin or eyes. Use disposable gloves, facemasks and eye protection. After handling wash hands and other exposed parts. If a vacuum is used for cleaning the coals or cleaning after servicing / installation it is recommended that it be of the type fitted with a HEPA filter.*

Disposal of refractory/ceramic materials. *To keep dust to a minimum these materials should be securely wrapped in polythene and be clearly labelled 'RCF waste'. These materials are not classified as 'hazardous waste' and should be disposed of at a site licensed for the disposal of industrial waste.*

INTRODUCTION

- The INFINITY 780 BF is an inset room sealed decorative fuel-effect gas appliance.
- The INFINITY 780 BF is available in **Natural Gas only**.
- The INFINITY 780 BF **must not** be installed into a natural draught flue or chimney.
- The INFINITY 780 BF should only be installed and serviced by a competent person i.e. GAS SAFE registered, in accordance with the GAS SAFETY (INSTALLATION AND USE) REGULATIONS.
- The INFINITY 780 BF does not require a chimney, but **must be** installed against an outside wall.
- It is important that the flue terminal is regularly checked and kept clear at all times.
- If the terminal is accessible to people (i.e. less than 2m above a walkway, balcony etc.) the terminal guard must be fitted to prevent access to the flue outlet, which becomes hot when the fire is in use.
- As the INFINITY 780 BF is a room sealed appliance (i.e. air for the combustion process is taken from outside the room) no purpose built ventilation is required.
- The INFINITY 780 BF is designed and tested to meet the requirements of the European Standard EN 613.

- The Appliance is for use on Natural Gas (G20 @ 20mbar) only.
- Failure to install appliance correctly could lead to prosecution.
- **In GB (Great Britain)**, the appliance must be installed by a competent person i.e. GAS SAFE registered, in accordance with the GAS SAFETY (INSTALLATION AND USE) REGULATIONS, The Building Regulations (or The Building Regulations (Scotland) or The Building Regulations (Northern Ireland)) and The Current I.E.E. Wiring Regulations, if appropriate.
- **In IE (Ireland)**, the appliance must be installed by a competent person and installed in accordance with the current edition of I.S.813 Domestic Gas Installation, the current Building Regulations and the current ETCI rules for electrical installation, if appropriate.
- Although the INFINITY 780 BF is fitted with a glass front which acts as a dress guard it is strongly recommended that a fireguard should be used for the protection of children, the elderly or infirm. Fireguards should conform to B. S. 6539 (1984) (Fireguards for use with solid fuel appliance).
- Care should be taken to prevent any damage being caused to surrounding soft furnishings or decoration. Many wall coverings may become discoloured if placed too close to the appliance, it is strongly recommended that any proposed wall covering intended for use immediately above the appliance should be tested in the hottest position (immediately above) first. Run the fire on high over a few days
- All combustible material must be removed from behind the fire and fire trim.
- The first time you light your new appliance a smell may occur due to its new condition. This is quite normal and will soon disappear after a few hours use at maximum setting (open a window until the smell disappears)
- With use the inside of the air box will change colour, particularly the sides and rear. This is quite normal and often adds to the overall effects of the appliance.
- The appliance **MUST NOT** be used if the glass panel is not correctly fitted or if this panel is cracked or broken.
- Any debris should be cleaned from the appliance. A vacuum cleaner can be used but only after all the loose shapes have been removed.
- ***Prior to removing or cleaning the logs refer to the 'Health and Safety Notice' located on page 3 of this booklet.***
- The appliance should be serviced annually by a competent person i.e. a **GAS SAFE registered engineer** in accordance with these instructions.
- The glass or any part of the appliance **MUST NOT** be cleaned or wiped whilst the appliance is **HOT**, to do so could be dangerous and may damage the paintwork of the appliance.

SECTION TWO Introduction (users instructions)

- The INFINITY 780 BF is an inset room sealed decorative fuel-effect gas appliance designed for use in locations that do not have a conventional chimney. The appliance must be installed against an outside wall because the air to support combustion is taken from the outside and the products of combustion are expelled to the outside.
- The appliance incorporates a safety device in the form of a FLAME SUPERVISION DEVICE, which constantly monitors the flame and will cause the gas to be switched off if the flames are extinguished for any reason. **THIS DEVICE MUST NOT BE OVERRIDDEN.** If this situation occurs on a regular basis have the appliance checked by a qualified engineer. The problem may be due to a blocked or restricted flue.
- Before removing the trim, glass shapes for cleaning the fire should be turned off, and left to cool down.
- **NOTE:** In use some discoloration of the components will take place in the combustion box, this is normal, but can be kept to a minimum if the shapes are placed correctly (i.e. after cleaning). See Section 4.
- As with all heating appliances certain areas (Working Surfaces) become very hot when the appliance is in use.



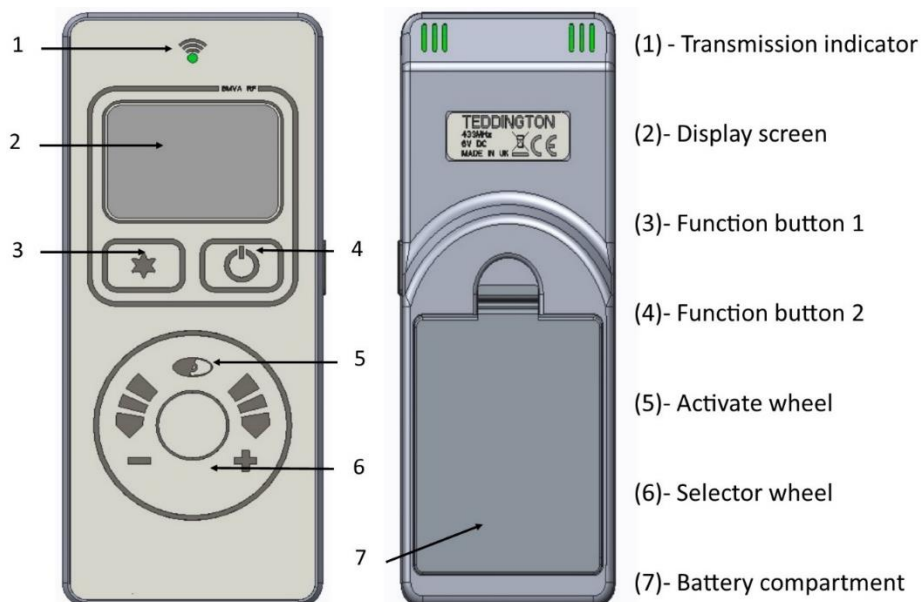

SECTION THREE Operation (users instructions)



Display overview

Press  to awaken the handset from its dormant sleep mode at any time. Fig 1 shows the display neutral, ready to turn on.

Turn on (start up).

Pressing and holding  displays an “UNLOCK” graphic Fig 2 prompting the  button to be pressed simultaneously. Whilst both  &  are pressed a progress bar Fig 3 will complete. If either button is released before the progress bar has completed the operation will cancel. Once the progress bar has completed the handset will display the status of the fire (priming – ignition – pilot – main burner) finishing at the fire “on” display screen Fig 4.

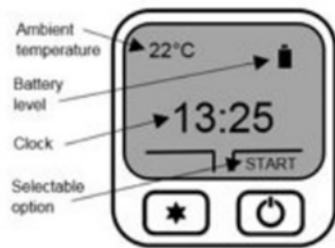

Fig 1 Neutral Display



Fig 2 Unlock graphic





Fig 3 Progress bar



Flame height adjustment

Once the fire has been started the flame height can be decreased by moving your finger clock wise or decreased moving your finger anti-clock wise using the selector wheel. Once the desired flame level is set, remove your finger from the selector wheel to transmit your selection to the receiver. Six flame levels and a pilot setting are selectable. Press  whilst the display is active to display the current flame level.

Turn off (shut down)

To turn the appliance off, press and hold down  until the progress bar has completed. If the  is released before the progress bar has completed the operation will cancel.

Mode select

With the fire running on manual operation you can access three further “modes”. Press  for “mode”. Use the selection wheel to cycle through the three options, “Auto”, “Sleep” and “Light”. Press  to select “Auto” or “Sleep”

Sleep:- Use the selector wheel to choose from the available time range of 5 minutes to 1 hour 30 minutes. Once the desired countdown time has expired the appliance will turn off. By pressing the  button during the countdown will cancel the countdown timer if required.

Note: The handset contains a sensitive temperature measurement device. To achieve the best thermostatic efficiency do not place the handset near the heat source, avoid covering, direct sunlight or near a draft or open window etc. Place the handset at a midpoint in the room or area being heated. Allow 5-10 minutes for the handset to stabilize if subjected to extremes of temperature.

Auto (Thermostatic) Control

Press  to awaken the handset from its dormant sleep mode at any time.

Selecting auto control

The “auto” function can only be selected once the appliances has been started and initiated into “manual” mode. Once in manual mode, press and release the  button to enter the “mode” options. Auto is the first option, press to enter auto mode.

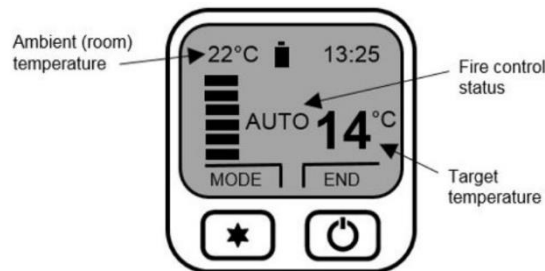

Fig 5 Auto Thermostatic mode



Adjusting target temperature

Use the selection wheel to increase or decrease the temperature to the desired level, release your finger from the wheel to transmit the target temperature (See Fig 5) to the receiver. The “auto” function will now modulate the flame height to achieve your target temperature. The selectable temperature range is 1 degree C to 29 degree C.



Cancelling auto function

Press  to “end” and cancel the “auto” control. The handset will return to manual control.

Menu features

The menu can be accessed by pressing and holding the  button (approx. 5 seconds) until the menu graphic completes (see fig 6). Use the selector wheel to highlight one of the available options. Press  to enter the required option.



Set clock

The handset clock has a dedicated 24 hour display. Use the selector wheel to firstly set the hours. Press  to change to minutes select. Use the selector wheel to change the minutes. Press the  button to alternate hours and minutes to make any other alterations. Finally, press the  button to save the clock setting.

Display

Temperature display units-use selector wheel to select either Celsius (degree C) or Fahrenheit (degree F). Press the  button to save selection.

Gas fire (pair code)

The device screen displays the current operating channel of the handset. To delete the channel press  &  simultaneously or  to return to the menu option.

Reset

To restore the handset back to its original factory setting select “reset” from the menu options. Press - & - simultaneously to complete the reset command – to return to the menu options.

Changing The Handset Batteries.

The handset operates from four AAA 1.5V batteries. New alkaline batteries are recommended. Do not mix new and old batteries. When inserting the batteries, observe and position batteries according to the battery compartment graphics (see Fig 7). When the batteries are inserted this handset will attempt to repair.



Fig 7 Battery compartment

SECTION FOUR Cleaning & Laying the fuel bed (users instructions)

Warning:-Before you clean any part of the appliance ensure that the appliance is switched off and cool.

CLEANING: BLACK PAINTED SURFACES

- These surfaces should be dusted regularly and any marks removed with a soft cloth.
- Abrasive or chemical cleaner should never be used.

CLEANING: GLASS PANEL

From time to time it may be necessary to clean the glass panel.

We recommend you use a Ceramic Hob Cleaner (brands such as **HOB BRITE** and **VITRO CLEN** have been found to be **acceptable**) these are available from most leading Supermarkets.

Remove the glass panel as follows:

- Carefully lift out the in fill covers LH and RH.
- Remove the top fixing cover.
- Remove the three of fixing bracket located on the top and sides of the glass panel.
- Carefully lift the glass panel up out off the bottom location. Lay the glass panel down on a flat working surface on top of an old opened newspaper with the side to be cleaned uppermost.

Follow the Instructions on the Hob Cleaner Bottle.

On stubborn stains (where the appliance has been used for a long period without glass panel being cleaned), use a new **Brillo Pad** well wetted with the Hob cleaner applied directly to it.

Ensure all the residues of the cleaner are removed with a damp cloth and the glass panel is completely dry before fitting to the appliance.

Note: - If the loose shapes have not been placed correctly, causing the gas flame to contact the glass this may result in glass staining that cannot be removed by cleaning.

- Re-assemble in reverse order ensuring a tight seal against glass assembly.
- Take care not to over-tighten the glass fixing nuts as this will cause the glass to break. Glass is not covered by warranty
- Re-fit the fascia.

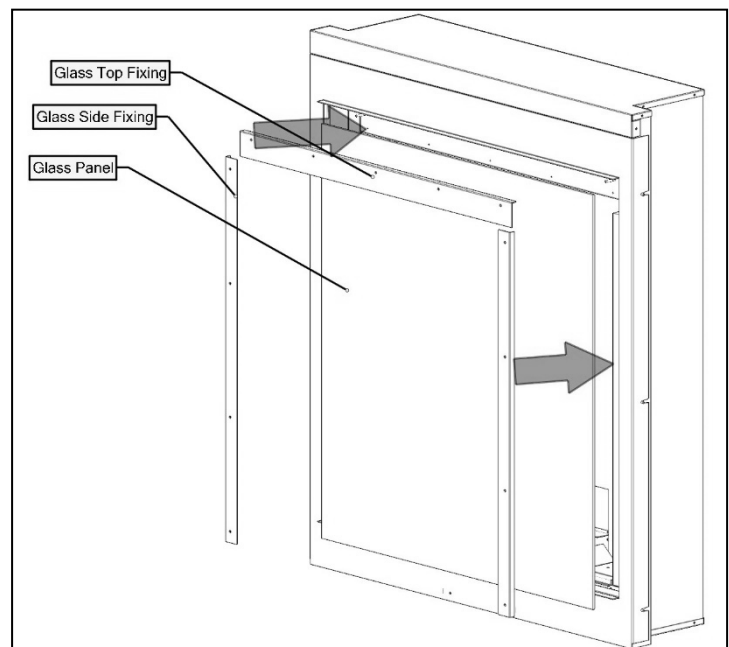
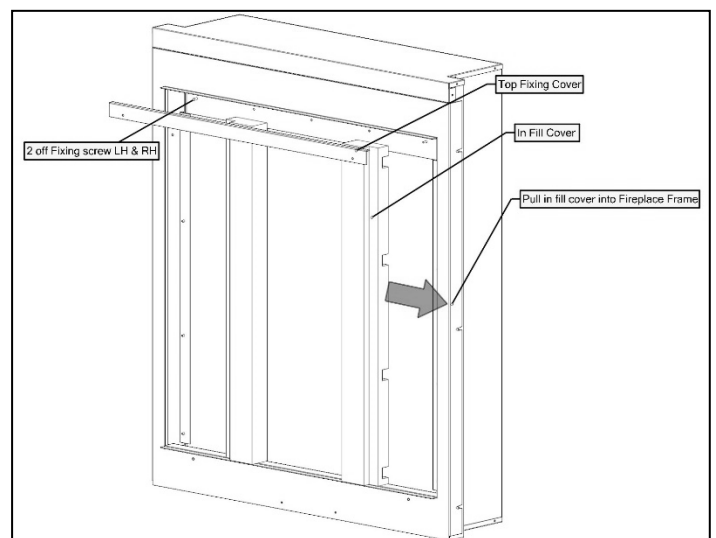

CLEANING AND REPLACING fuel bed shapes

Important: - Refer to the 'Health & Safety Notice located on page 3 of this booklet before cleaning or replacing any refractory material.

Use only the shapes provided **NO OTHER SHAPES SHOULD BE ADDED** to the appliance

The Fuel bed set consists of:

- 13 Log Shapes.
- Bark chippings
- 1 Bag Embaglow

Log Fuel Bed Layout.



Place strands of emberglow across lighting ports. Strands to be placed to bridge the front and rear burner shields

Within this packed appliance is one packet of Ember glow. Only half of the packet should be used per install, the spare half of the pack is provided for the first annual service. Failure to place the correct amount of flakes and in the correct burner area can result in producing a poor flame picture and sooty deposits.

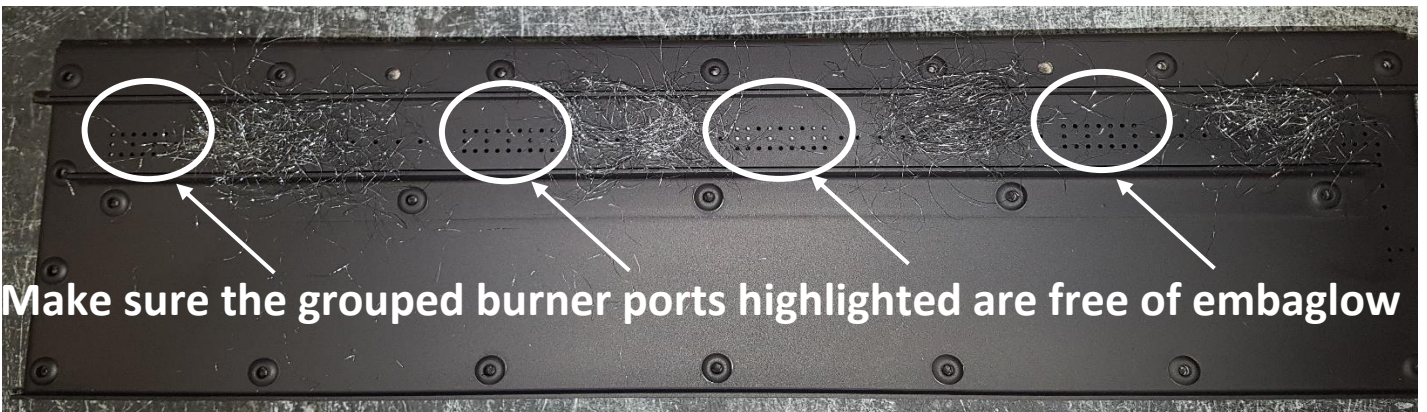

Make sure the grouped burner ports highlighted are free of embaglow



Lay the bark chippings and small log shape as shown.



- Place two log shapes upon the shelf above the inlet baffle as shown.



- Place a further two log shapes along the front edge of the burner cover.
 - Place a further two log shapes as shown.

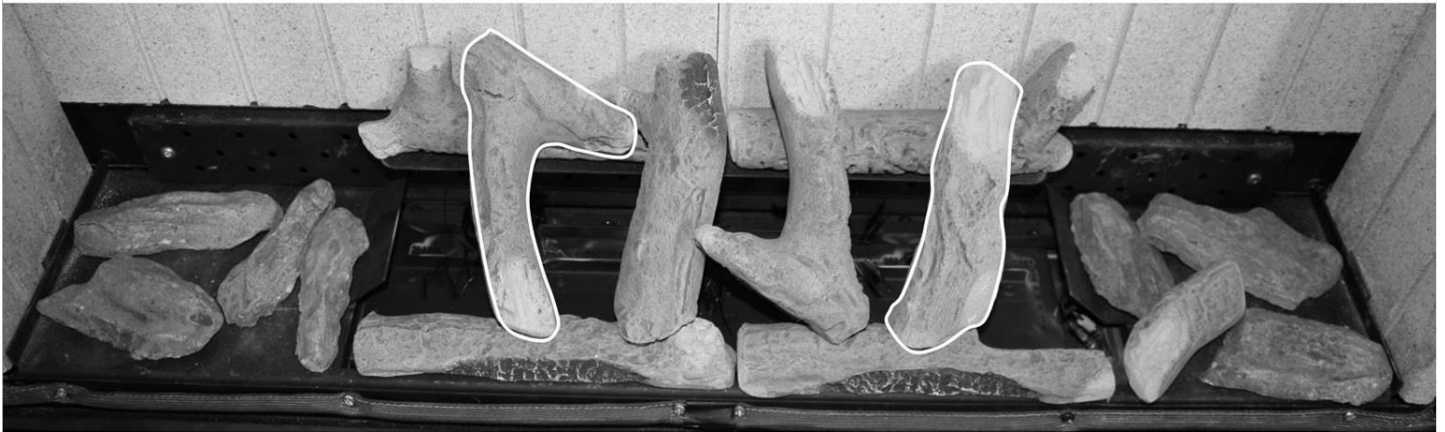

- Place a further two log shapes as shown.
- Place a further two log shapes as shown.
- Finally place a further two log shapes as shown.



SECTION FIVE Appliance Data (installation instructions)

Fire Box dimensions:..... Height 740mm

Width 843mm

Forward Projection:.....42mm

Weight:.....35kg

Flue Length.....100mm (minimum) to 600mm (maximum)

No bends or joined flue pipes should be used in the flue system.

Pressure Test Point Location:..... Gas inlet elbow

Gas Connection:.....8.0mm O/D, tube.

Data Badge Location:..... On bottom right hand side of firebox behind trim.

MODEL	Natural Gas (G20) Version
Category of appliance	C _{II}
NO _x Class	4
Efficiency Class	1
Gas Category	I _{2H}
Gas Type	G20 Natural Gas
Gas Pressure +/- 1.0mbar	20 mbar
Gas Input (Max)	5.1 KW Gross
(Min)	2.4 kW Gross
Injectors size	MK360A Mark
Handset Replacement Batteries 4 x AAA 1.5V	
Power Supply Type Plug – Input : 100-240 VAC 50/60 Hz, 0.2A	

NOTE: The efficiency of this appliance has been measured as specified in BS EN613-2001 and the result is 75.8% natural gas. The gross calorific value of the fuel has been used for this efficiency calculation. Gastec have certified the test data from which it has been calculated. The efficiency value maybe used in the UK Government's Standard Assessment Procedure (SAP) for energy rating of dwellings.

SECTION SIX Regulations and Warnings (installation instruction)

- This appliance must only be installed in Great Britain or Ireland.
- The appliance is available in natural gas only.
- This appliance must be installed on a suitable outside wall.
- No special ventilation bricks or vents are required into the room containing the appliance.
- **In GB (Great Britain)**

It is the law that all gas appliances must be installed by a competent person; i.e. a GAS SAFE registered installer, in accordance with the current Gas Safety (Installation and Use) Regulations (as amended), all relevant parts of the local and national building regulations and all relevant recommendations of the current British Standards. Failure to do so could lead to prosecution.

The following are the relevant codes of practice and British Standards: -

B.S. 5871 PART 2

B.S. 5440 PART 1

B.S. 6891

B.S. 1945

Note:- This appliance must be installed to current versions of the above standards and include any relevant amendments.

The Building Regulations issued by The Department of the Environment.

The Building Standards (Scotland) (Consolidated) Regulations issued by The Scottish Development Office.

- **IN IE, (Ireland)**

The appliance must be installed by a competent person and installed in accordance with the current edition of I.S.813 Domestic Gas Installation, the current building regulations, and the current ETCI rules for electrical installation, if appropriate.

WARNINGS

- As this appliance has components, which get very hot as with all such fires, it is recommended that a fireguard should be used for the protection of children, the elderly, or the infirm. Fireguards should conform to B.S.6539 (1984) (Fireguards for use with solid fuel appliances).
- During initial use, an odour may be evident. This will soon disappear if the fire is run on its maximum setting for a few hours.
- Care must be taken to prevent any damage being caused to surrounding soft furnishing or decoration, e.g. wall coverings may become discoloured if placed too close to the appliance.
- To reduce heat transfer to the surround it is recommended that the header is packed with "Rockwool"

SECTION SEVEN Siting the Appliance (installation instructions)

(When installing in a timber framed dwelling reference must be made to the specific installation requirements stated in **Section 8 Installing the Appliance in Timber Framed Dwelling**).

GENERAL REQUIREMENTS

- The flue and air duct length must be between 100mm to 600mm.
- The fire is supplied with a standard pipe length of 600mm.
- The flue and air duct must not have any bends.
- The flue outlet must terminate on a suitable outside wall.
- The minimum flue terminal clearances, which must be maintained, are as shown below.

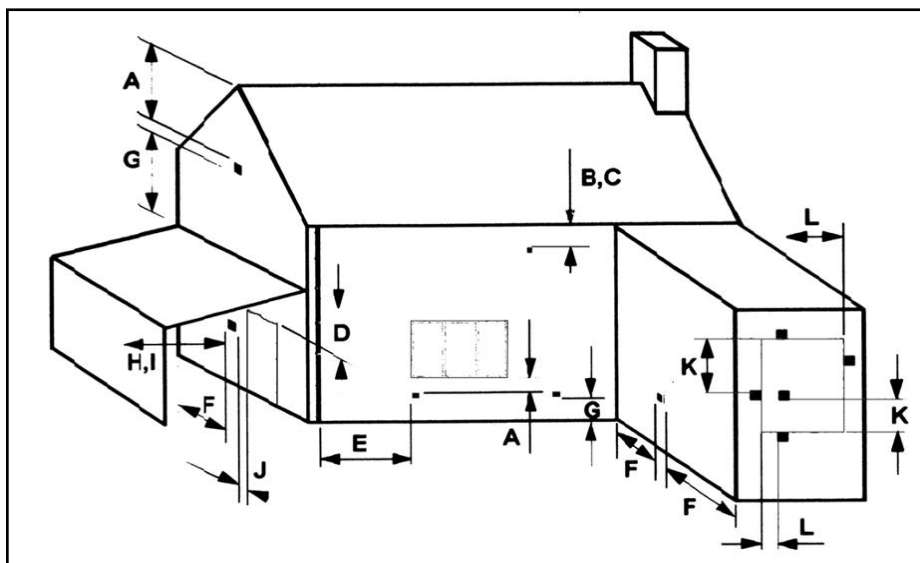

A. Directly below an openable window or other opening. E.g. air brick.....	300mm
B. Below gutters, soil pipes or drain pipes.....	300mm
C. Below eaves.....	300mm
D. Below balconies or carport roofs.....	600mm
E. From vertical drain pipes and soil pipes.....	75mm
F. From internal and external corners.....	300mm
G. Above ground, roof or balcony level.....	370mm
H. From a surface facing the terminal.....	600mm
I. From a terminal facing the terminal.....	1200mm
J. From an opening in a car port into a dwelling e.g. door, window, etc.....	1200mm
K. Vertically from a terminal on the same wall.....	1500mm
L. Horizontally from a terminal on the same wall.....	300mm

Please note with early cavity wall design prior to 1970. The minimum depth requirement may well be difficult to obtain. This could result in the need for the firebox to be spaced further from the internal surface of the plaster and to achieve this larger rebated surround maybe necessary.

Ensure that gas supply is suitably sited

- Check with the supplier or manufacturer that the surround meets 150°C minimum rating (attention should especially be given to manmade materials such as resin).
- When installing in a timber framed dwelling reference must be made to the specific installation requirements stated in

Clearance to Shelf

Minimum clearance from hearth or base of opening to underside of combustible shelf should be 880mm provided the shelf depth is 75mm (3"). This gives a minimum clearance above the appliance of 140mm. For a shelf of 150mm (6") the minimum height above the hearth or base of opening must be 960mm. This will give a minimum clearance above the appliance of 220mm.

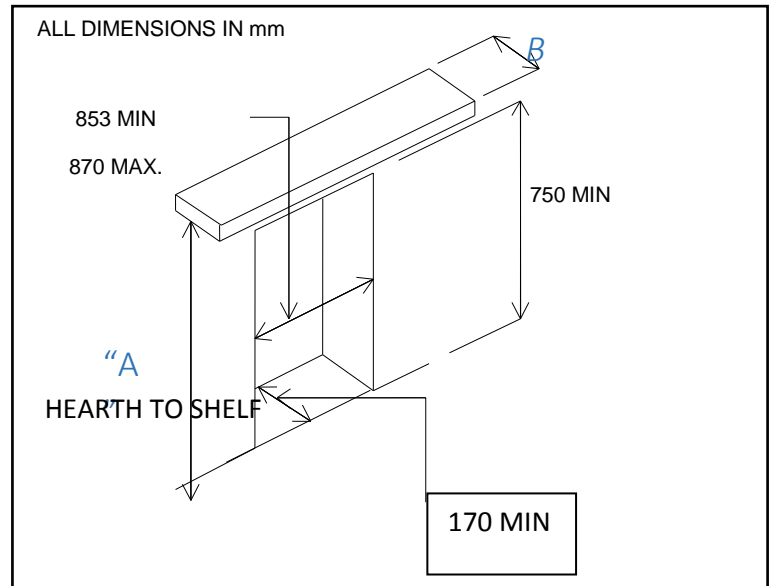

Clearance to Sides of Fire

Minimum width between vertical sides of combustible surround should not be less than 875 mm provided fire is central to the surround and sides do not project more than 150 mm. When vertical side forward projection is increased by 12.5 mm add 50 mm to inside width of surround.

SECTION EIGHT Preparing the Appliance for Installation (installation instructions)

- Carefully unpack the appliance from the carton and check the contents.
- Lift away the Box of ceramics, glass panel and Fire frame components.
- Remove the refractory components from the inside of the packaging.
- The appliance is now ready for installation.

INSTALLING THE APPLIANCE INTO CAVITY WALL Ensure it is a suitable outside wall constructed of non-combustible materials and that the flue position meets the requirements previously described in Section 8.

- Mark a vertical line on the wall at the intended centre of the appliance up from the horizontal line for a height of 887mm.
- If inseting into the wall mark the position for a lintel (Minimum 1040mm) above the top horizontal line.
- Using a long masonry drill, make one pilot hole completely through the wall. Ensure the hole is drilled accurately at the centre and square to the wall both horizontally and vertically at the cross points previously marked.
- If inseting into the wall proceed as follows: Cut out the brickwork of the inner skin of the cavity wall for the lintel, and fix the lintel.
- Cut out the brickwork under the lintel, between the two outside vertical lines into the cavity. Ensure the cut out width is square and try the appliance into the opening.

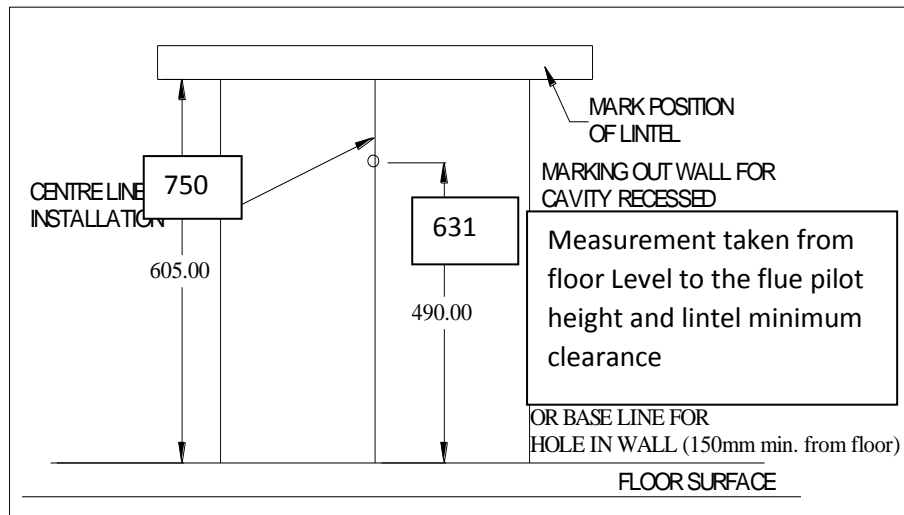

Using 150mm core drill cut a holes following the pilot holes. Drill from the outside through to the cavity to give a good finish on the outside.

- Remove any cavity insulation from the cut out opening and for a further 100mm into the cavity gap each side and above.
- Pack “Rockwool” around the sides and top of the opening into the cavity for a depth of 100mm. Also put some behind the firebox if space is available.
- Offer the appliance into the opening and mark through the gas pipe entry hole (see connecting the gas supply section).
- Pass a tape measure through the core-drilled hole and record the distance from the back of the fire to the outside wall
- Cut the outer tube to the recorded length. Add 15mm to this measurement to determine the length of the inner tube and cut to size. **NOTE: The inner tube will be 15mm longer than the outer tube**
- Remove the appliance from the opening, and position the gas supply (see connecting the gas supply later in this manual), taking account of the relative gas regulations regarding a gas pipe in a cavity (sleeving and sealing etc). Note the gas feed must be fitted with the isolation valve supplied.
- Push the appliance back into the opening and fill any space behind the appliance with “Rockwool”.
- Complete the gas connection (see connecting the gas supply later in this manual).
- Drill the four fixing holes through the hole in the flange of the appliance and fix back using plug and screws.
- If the flue outlet is fitted below 2m from the floor or a balcony then the flue terminal guard must be fitted.

INSTALLING THE APPLIANCE WITH A DUMMY CHIMNEY BREAST

This method of installation allows the appliance to be wall mounted on to a suitable outside wall without the need to create an opening within the cavity. This can be used where the desire to create a feature chimney breast is wanted within the room.

The feature chimney breast should only be constructed with Skamotec 225 as this is the only method we have found to work satisfactorily.

Guidance can be found here <http://www.ims-insulation.com/products/fireplace-enclosures/>

- Fit the universal wall mounting brackets to either side of the appliance using the same fixings as the fireplace frame

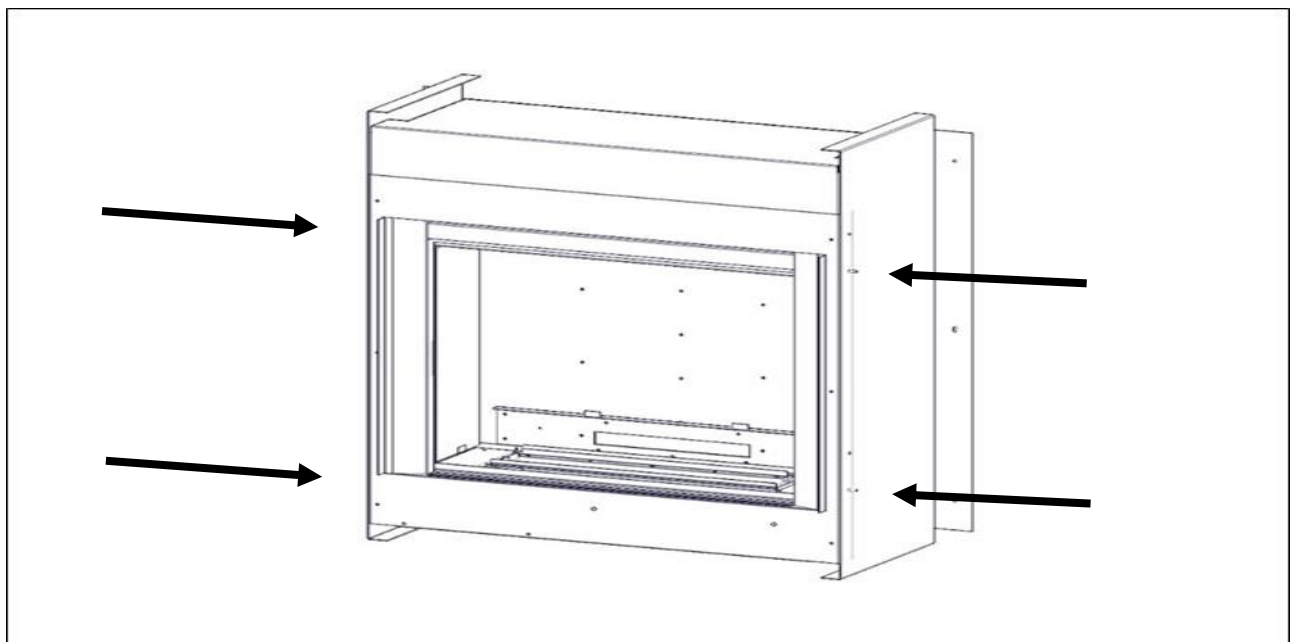
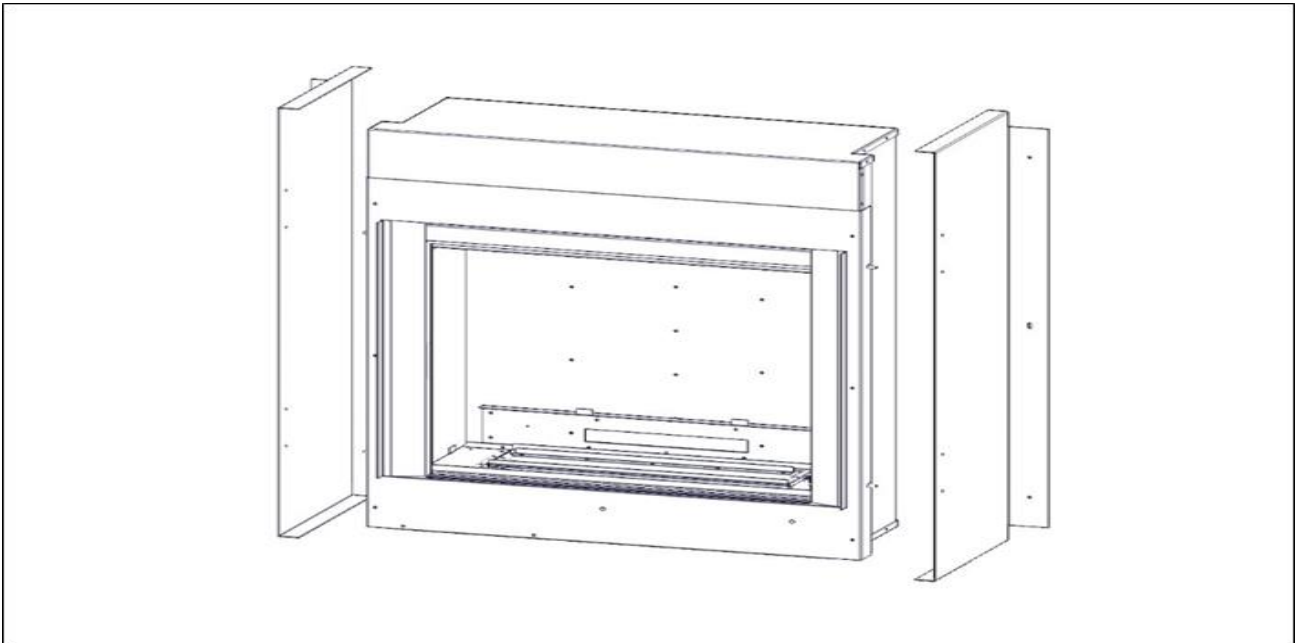

Ensure it is a suitable outside wall constructed of non-combustible materials and that the flue position will meet the requirements previously described in **Section 7**

- Mark a vertical line on the wall at the intended centre of the appliance and fireplace.
- Mark a line 482mm above the intended finished base level.
- Using a long masonry drill, mark one pilot hole completely through the wall. Ensure the hole is drilled accurately at the centre and square to both the wall horizontally and vertically at the cross point previously marked.

- Using a 150mm core drill from outside cut a hole following the pilot hole. Drilling from the outside through to the cavity will give a better finish on the outside wall.
- Remove any cavity insulation from the core drill cut out opening and for a further 100mm into the cavity gap all around.
- Pack “**Rockwool**” around the opening into the cavity for a depth of 100mm.
- Offer the appliance up to the opening and mark through the gas pipe entry hole (see connecting the gas supply section).
- Pass a tape measure through the core-drilled hole and record the distance from the back of the fire to the outside wall
- Cut the outer tube to the recorded length. Add 15mm to this measurement to determine the length of the inner tube and cut to size. **NOTE: The inner tube will be 15mm longer than the outer tube**
- Cut the length from the 600mm flue pipe provided. Ensuring that the pipe is cut squarely and deburred using a file or emery paper.
- Install the flue terminal on the outside wall ensuring it is vertical and the terminal shield is at the top.
- If the flue outlet is fitted below 2m from the floor or a balcony then the flue terminal guard must be fitted.
- Remove the appliance from the opening and position the gas supply.
- Using flue seal or fire cement apply a small bead to internal ends of both the inner and outer pipes to ensure an airtight seal is made when the fire is positioned onto the flue.
- Position the fire onto the flue ensuring they are fully mated and wall mounting brackets are in contact with the wall face.
- Level the appliance and then drill and fix the wall brackets to secure the fire.
- Complete the gas connection as outlined in section Nine.

Construction of the Chimney breast

<http://www.ims-insulation.com/products/fireplace-enclosures/>

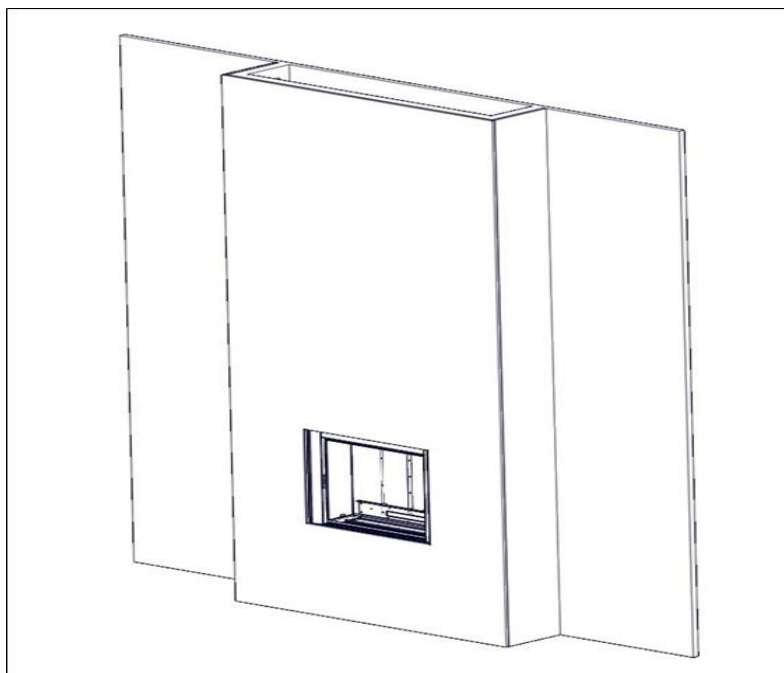

Contained within the kit are 4 80mm Circular vents which should be fitted on either side of the enclosure.

They should be installed 125mm up from the floor and 125mm down from the ceiling

SECTION NINE CONNECTING THE GAS SUPPLY

TURN OFF ANY GAS APPLIANCES THAT ARE FED BY THE METER AND ISOLATE THE GAS SUPPLY BY TURNING OFF AT THE METER.

- The Gas Connection can be made by removing the gas inlet cover located on the left hand side of the fire box sump assembly. Remove the 8 off fixing screw and remove the plate plus gasket. **Please note special attention should be taken not to damage the gasket.**
- You will then have access to the isolating cock which is fitted in the supply feed.
- When a concealed gas fitting from the rear is required it is necessary to route the pipe to the left side of the unit, taking into account the requirements of BS 6891 1988 dealing with enclosed pipes.
- When installing the firebox into a cavity wall, any part of the installation pipe work installed in the void open to the cavity wall must be enclosed in a gas tight sleeve. It must be sealed at the point at which the sleeved installation pipe enters the fire (The Gas Safety (Installation and Use) Regulations Certificate of exemption number 1 of 1996). Where the pipe enters the fire the outer sleeve must be sealed to the grommet and the pipe must be sealed to its outer sleeve using suitable mastic.

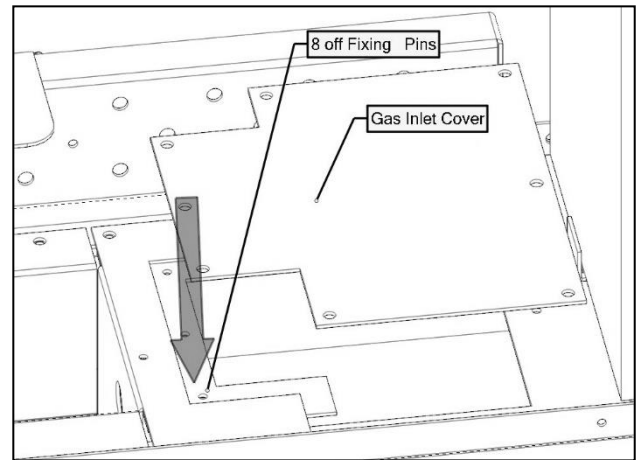

CHECK BURNER PRESSURE AND GENERAL OPERATION

- Remove the screw from the pressure test point on the burner inlet elbow and fit a pressure test gauge.
- Turn on the gas to the appliance and operate as described in section three. Check that the inlet pressure 20mbar +/- 1 mbar for natural gas.
- Turn off the appliance and remove pressure test gauge.
- Refit the screw into the pressure test point and turn on the appliance again, check that the screw has sealed with leak detection fluid.
- Turn the appliance off.
- **Refit the gas inlet cover and gasket. Please note special attention should be taken not to damage the gasket, and ensure an adequate seal is made.**

Power lead routing

The power supply for this appliance is provided via AC power adaptor 230 VAC. The main cable terminates at the rear Right hand side of the fire box. The length of the cable provided with the appliance is 1.65 metres. Care must be taken when siting the fire box not to trap the exposed main cable within the builders opening.

Note: the power cable link to the transformer must be accessible for repairing handset and use with the battery holder

The cable can be routed using the following two methods,

Method 1

Passing the cable through the side of the chimney breast. It is good practice to run the cable within a sleeve of at least 15mm internal diameter, sealing the sleeve using a suitable sealant at the point the sleeve / cable terminates the chimney masonry.

Method 2

Remove a channel out of the outer skin of the Dry / wet plaster of the chimney breast up to the main power point. Again it is good practice to run the cable within a sleeve of at least 15mm internal diameter.

With power points that exceed the 1.65 metre distance, an optional 2.0 metre extension cable is available Part No 7147.

The cable system consists of retro fitting plug sockets which offers the following options. (Please see figure 5).

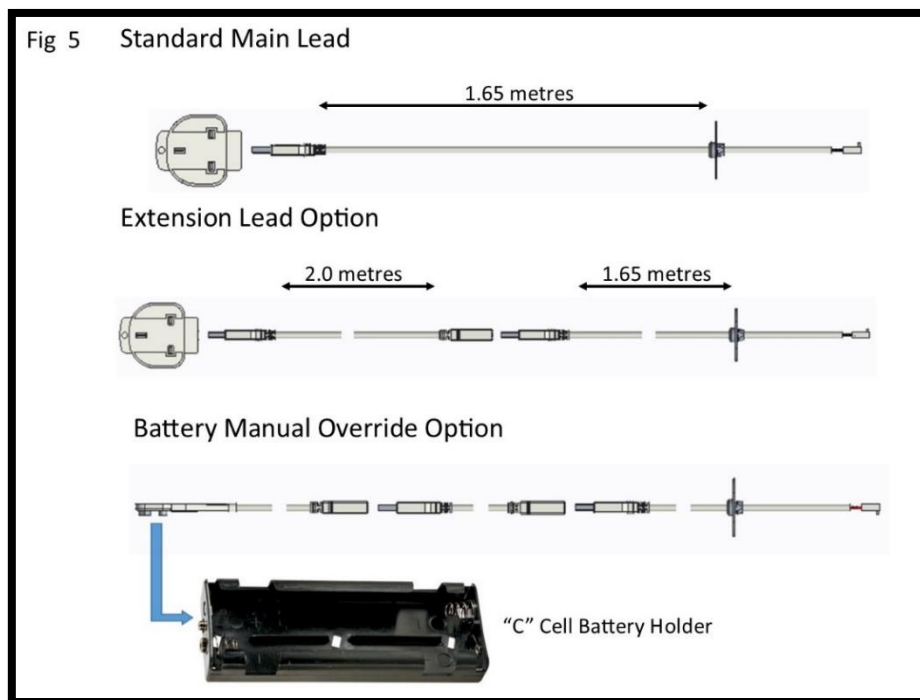

SECTION TEN Assemble the appliance (installation instructions)

- Taking special care remove the ceramic liner set from within the packaging. The rear liner is in two pieces. Place the bottom rear liner upon the top edge to the air tray. Angle the upper rear line into the fire box assembly and place on top of the rear bottom line.
- With the two rear liner in position. Offer the LH and RH side liner into the bottom brackets within the burner Shelf assembly. (Please note the patterned edge must be positioned along the front). Push the top of the liner back into the chamber sides and bend the finger fold brackets to locate the side liners.
- Fit the burner cover within the base of the burner tray.
- Position the shapes components as described in section four of this manual; it is important that the shapes are positioned exactly as described to ensure the correct operation of the appliance. Badly positioned shapes may result in the gas flame being driven forward onto the glass and permanently marking it.
- The fireplace frame can now be fitted by sliding the assembly over the 4mm location studs positioned on the LH and RH flange of the fire box. When positioned tighten all six off fixings.
- Taking great care, locate the glass panel within the gap between bottom retaining bracket and glass seal.
- When located push back against the seal and locate and tighten the three fixing brackets. (Please note over tightening the fixing nuts can result in damage to the glass panel) Glass is not covered by warranty.
- Load 6 off of the 1.5 v "C" batteries into the holder provided and attach to battery lead. Locate the loaded
- Holder within the bracket at the bottom of the fireplace assembly.
- Fit the Inlet cover at the bottom of the appliance between the glass panel and fireplace frame assembly.
- Finally Slide the LH and RH infill strip within the fireplace frame and the glass panel.
- When assembly is complete please refer to section three operation.

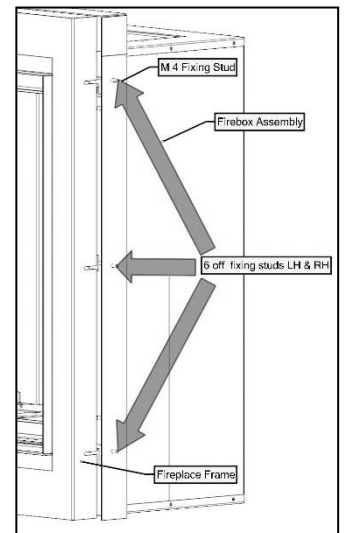
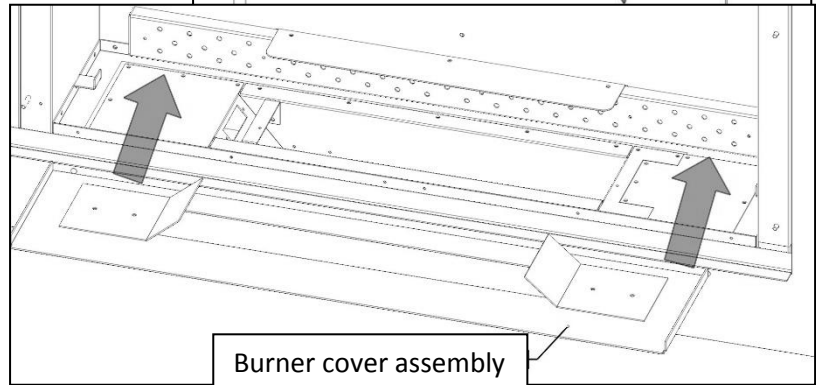
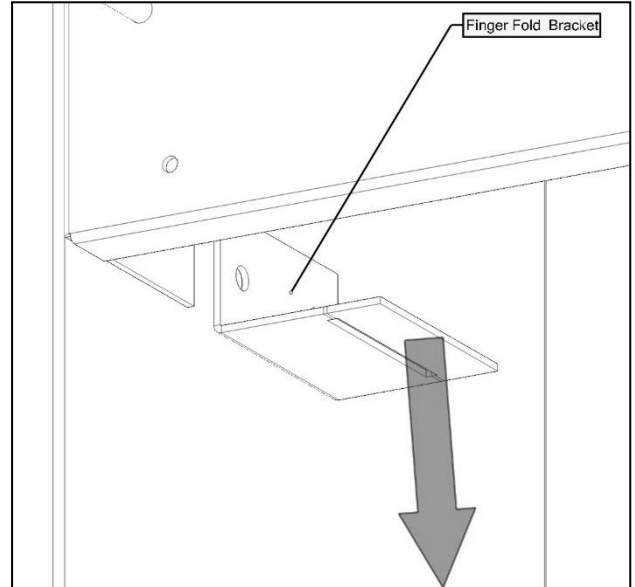

SECTION ELEVEN Instruct and Advise the Customer (installation instructions)

- Demonstrate the lighting and extinguishing procedure to the consumer/user and the removal and refitting of the trim for cleaning.
- Explain that for the first few hours of the fire operating there will be an initial odour. This is due to the curing of the paint, the appliance should be operated on its high setting, and it is recommended that a window is left open until that odour has completely disappeared.
- Instruct on the glass removal and refitting.
- Instruct on the shapes cleaning and advise that a vacuum cleaner can be used but only after all the loose shapes have been removed. **Refer to 'Health & Safety Notice (See Section One) at the front of this booklet before proceeding.**
- Advise customer that with use the inside of the air box will change colour, particularly the sides and rear. This is quite normal and often adds to the overall effects of the appliance.
- Advise that the appliance should be serviced annually by a competent person i.e. a **Gas safe registered engineer** in accordance with these instructions.
- Although the appliance is fitted with a glass front which acts as a dress guard it is strongly recommended that a fireguard should be used for the protection of children, the elderly or infirm. Fireguards should conform to B. S. 6539 (1984) (Fireguards for use with solid fuel appliance).
- **Hand these instructions to the user.**

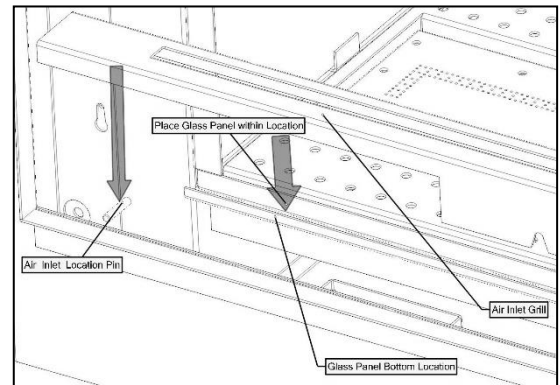

SECTION TWELVE (Maintenance Instructions)

General

- Servicing should be carried out annually by a competent person such as a GAS SAFE-registered person in accordance with the relevant regulations, to ensure the safe and correct operation of the appliance.

Warning: - Before commencing any service or replacement of parts, turn off the gas supply to the fire.

- After servicing check for gas soundness.
- When ordering spare parts please quote appliance name and serial number these can be found on the data badge, which is located on the left hand side of the base of the appliance.
- If soot has accumulated check to establish cause, rectify and clean flue accordingly.

Important: - Refer to 'Health & Safety Notice (See Page 3) at the front of this booklet before removing the fuel bed components.

- Examine the shapes for signs of cracking and replace if necessary.(IMPORTANT) see shape layout procedure in section four of this manual before attempting to replace items, which should only be replaced as a complete set with no extra shapes added.

Replacement of Injector

1. Repeat operations 1-9 for removal of gas control.
2. Clean or replace injector and replace in reverse order, ensuring that the seal around the injector fixing is sound (change if in doubt).
3. Turn on the gas supply, check for soundness and re- commission.

Replacement of Gas Control

1. Remove the infill strips LH and RH and the inlet cover.
2. Remove the 3 off glass retaining brackets positioned on both sides and top of the glass panel.
3. Remove the glass panel.
4. Remove all shapes and the burner cover plate.
5. Remove the fixing screws from the gas inlet cover and gasket and shut off restrictor. Break the 8mm compression joint on burner tray outlet pipe.
6. Remove the 3M nut which attaches the EDB unit to the base of the firebox.
7. Remove all the No 6 screws fixing the burner sump to the firebox shelf. Lift the complete burner sump assembly and gasket out of the firebox shelf.
8. With the sump assembly removed. Disconnect the Valve Motor wire, Ignition wire and Thermocouple interrupter wires from the E.D.B.
9. Disconnect all the pipes and thermocouple from the Gas Valve.
10. Change, service or replace the valve and re-assemble in reverse order.
11. Re-assemble the complete tray into the fire in reverse order and re-connect all parts.
12. Turn on the Gas supply, check for soundness and recommission.

Replacement of the Thermocouple

1. Remove the Thermocouple from the rear of the Valve.
2. Disconnect the Thermocouple wires from the E.D.B.
3. Undo the Thermocouple nut from the pilot assembly, remove the Thermocouple and replace.
4. Replace in reverse order, turn on gas supply, check for soundness, correct operation and re-commission.

Replacement of the Pilot Injector

1. Repeat operations 1-9 for removal of gas control.
2. Undo the pilot tube nut at the pilot bracket.
3. Pull the pipe gently back taking care not to damage pipe or olive hook nut.
4. Remove the pilot injector from inside the pilot bracket.
5. Clean or replace pilot injector

Replacement of the EDB Unit

1. Remove the M3 nuts holding the Heat Shield, remove the M3 nut and remove the E.D.B.
2. Pull the E.D.B. forward and remove all the wires & connections
3. Replace E.D.B. and reconnect all the wires
4. Re-assemble in the reverse order.

Turn on the gas supply, check for gas soundness, operation and re-commission appliance.

Replacement Handset

Follow the guide stipulated on page 8 of the users instructions “Changing the handset batteries” to load the batteries into the new handset.



The replacement handset will need to be paired again to the ECU unit.

Pairing Handset

- Press eye button to wake handset
- Press & hold star button till menu is displayed – wait for box to fill
- Use wheel to scroll to display – “gas Fire”
- If not paired select – “PAIR”
- While fire is searching disconnect the power lead from the transformer
- Reconnect the transformer (should hear a beep to confirm power reconnected)
- Fire should then be paired

If the handset not pairing try breaking the power link from the transformer – then get the handset to pairing stage and then reconnect the transformer

To delete Pairing

Press and hold  (approx. 5 seconds) until the menu graphic Completes (see Fig 3). This will access the menu (see Fig 4). Use the selector wheel and select the “gas fire” option. Press  &  simultaneously to delete the current channel. The handset will re-load to “NO DEVICE” see Fig 4) screen.

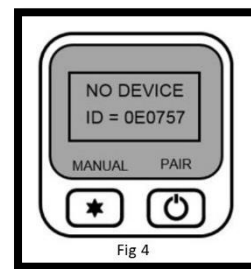
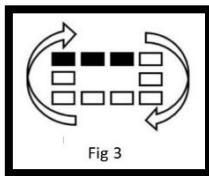

When ordering parts quote 'INFINITY 780 BF' and the serial number of the fire, which can be found on the data badge on bottom left hand side of fire. (Refer to cleaning instructions for trim removal.)

SECTION TWELVE Wiring Diagram (maintenance instructions)

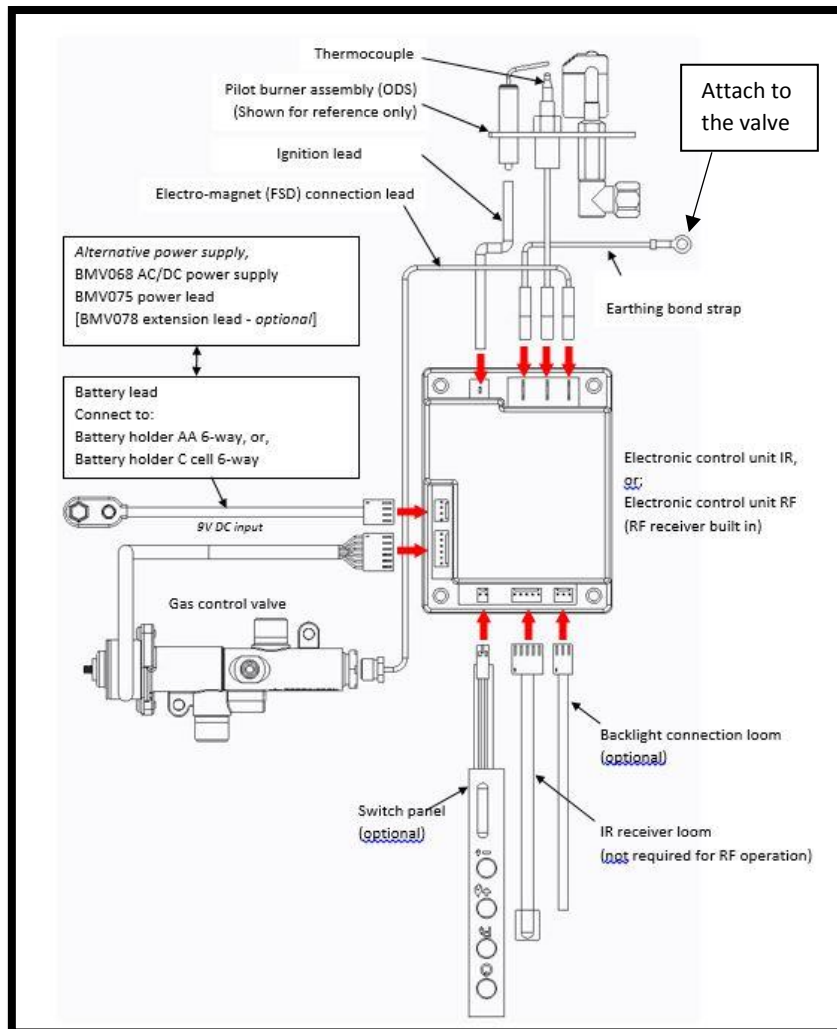

Register your appliance online today to activate your warranty



BALANCED FLUE GAS FIRE COMMISSIONING CHECKLIST

This Commissioning Checklist is to be completed in full by the competent person who commissioned the gas fire as a means of demonstrating compliance with the appropriate Building Regulations and then handed to the customer to keep for future reference.

Failure to install and commission according to the manufacturer's instructions and complete this Benchmark Commissioning Checklist will invalidate the warranty. This does not affect the customer's statutory rights. **PLEASE COMPLETE IN BLOCK CAPITALS.**

Customer name:	Telephone number:
Address:	
Gas Fire make and model:	
Installation location: i.e living/dining room.	
Gas Fire serial number:	
Commissioned by (PRINT NAME):	Gas Safe register number:
Company name:	Telephone number:
Company address:	
	Commissioning date:
Building Regulations Notification Number (if applicable):	

Site Requirements	Yes	N/A
Is the flue terminal sited and fitted as per the manufacturer's instructions?		
Has a terminal guard been fitted?		
Hearth Requirements- where fitted		
Is the hearth constructed from non -combustible material?		
Is the hearth a minimum of 12mm thick with a minimum floor to top surface of 50mm?(BS5871) or as per manufacturer's instructions?		
Is the hearth for open fronted fires a minimum of 760mm wide and has 300mm projecting from the fire opening (BS6871) or to manufacturer's instructions?		
Mounting height (where applicable) has the fire been installed to the correct mounting height- as per manufacturer's instructions?		
Firebox and Fuel Bed		
Has the fuel bed, coals, logs, pebbles etc. been fitted to manufacturer's instructions?		
Gas Supply		
Has an isolation valve inlet elbow been fitted for servicing?		
Has the gas supply been thoroughly purged prior to connection to remove any debris?		
Has a gas tightness test been completed prior to breaking into the gas supply and following completion of installation?(IGEM/UP/1B)		
Has the correct gas type been chosen as per manufacturer's instructions?		
Record burner gas pressure reading? If only the supply pressure is available a gas rate must be undertaken.(GSIUR REG26/9C)		
Record dynamic inlet gas pressure (working pressure) reading (all gas appliances running)		
Installation		
Has the gas fire/convector heater been installed and commissioned in accordance with manufacturer's instructions?		
Has the gas fire/convector heater been installed with the correct clearance to combustible materials, service and general clearances adhered to as per manufacturer's instructions?		
The operation of the fire/convector heater and controls have been demonstrated and understood by the customer, including replacement of batteries?		
The manufacturer's literature, including Benchmark Checklist and Service record has been explained and left with the customer?		
Has the appliance been registered with the Local Authority, as detailed on the Gas Safe web site and is a legal requirement and forms part of the warranty?		
Commissioning Engineer's Signature		
Customer's Signature (To confirm satisfactory demonstration and receipt of manufacturer's literature)		

*All installations in England and Wales must be notified to be Local Authority Building Control (LABC) either directly or through a Competent Persons Scheme. A Building Regulations Compliance Certificate will then be issued to the customer

SERVICE RECORD

It is essential that your gas fire is serviced regularly and that the appropriate Service Interval Record is completed. Service Provider

Before completing the appropriate Service Record below, please ensure you have carried out the service as described in the manufacturer's instructions. Always use the manufacturer's specified spare part when replacing controls.

SERVICE 01	Date:
Engineer name:	
Company name:	
Telephone No:	
Gas safe register No:	
Comments:	
Signature	

SERVICE 02	Date:
Engineer name:	
Company name:	
Telephone No:	
Gas safe register No:	
Comments:	
Signature	

SERVICE 03	Date:
Engineer name:	
Company name:	
Telephone No:	
Gas safe register No:	
Comments:	
Signature	

SERVICE 04	Date:
Engineer name:	
Company name:	
Telephone No:	
Gas safe register No:	
Comments:	
Signature	

SERVICE 05	Date:
Engineer name:	
Company name:	
Telephone No:	
Gas safe register No:	
Comments:	
Signature	

Product ID Label	A-0552	Serial No Prefix	PZ(NG)
Data Badge			
Burner Tray / Box Assembly			
Air Test Completed			
Warning Label (1409)			
Grommet (1406)			
Glass Sub-Assembly			
Silicone Sealing Strip (4818) x 2			
780 BF Log Set (6792)			
Fireplace Frame (5772)			
Battery Holder (5775)			
Inlet Cover (5764)			
Top Fixing Cover (6780)			
"AAA" Batteries (4)			
Remote Control Hand Set			
Handset Holder (7191)			
7mm Spinner (5435)			
Owners Book			
Transformer (Power lead)			
Burner Cover (6779)			
Side Covers (6785 & 6786)			
Snorkel Flue Assembly (packed in separate carton)			
Embaglow (6844)			
Inspector			
Serial Number			