



# 800HD BF UBL

## Instructions for user, Installation & Servicing



**With Under Bed  
Lighting**

Keep this booklet for service log and future reference

### IMPORTANT



This appliance is guaranteed for 12 months subject to conditions. The 5 year extended parts warranty will only be valid if the annual service recommended in this manual has been completed and appliance has been registered online.

**For use in Great Britain and Ireland.  
Literature NO 8381 (ISS 01)**

# Contents

Extended 5 Year Parts Warranty .....	2
Benchmark Scheme.....	3
Consumer Protection Info .....	4
Introduction .....	5
Handset set up.....	6
Auto (Thermostatic) Control .....	8
Menu Features .....	9
Under Bed Light Feature .....	10
Changing Handset Batteries .....	11
Cleaning Appliance/Glass .....	12
Fuel Bed Layout .....	14
Appliance Data .....	20
Regulations & Warnings .....	21
Siting the Appliance .....	22
Preparing the Appliance .....	23
Connecting Gas & Power Supply .....	25
Commissioning the Appliance .....	26
Appliance Assembly .....	26
Instruct & Advise Customer .....	27
Maintenance .....	28
Fault Finding Charts .....	32
Service Log .....	36
GAS FIRE COMMISSIONING CHECKLIST .....	38
Register Your 12 Month Warranty .....	41



## EXTENDED FIVE YEAR PARTS WARRANTY

**In order to validate your extended 5 years parts warranty please read the Benchmark Scheme on the opposite page and ensure your installer has filled in the appropriate checklist.**

**This in no way reduces your statutory rights**

Your warranty commences from the date of purchase and you must retain your receipt or invoice as proof of a purchase date.

**THIS EXTENDED WARRANTY SPECIFICALLY EXCLUDES GLASS AND SOFT REFRACTORY COMPONENTS, THE BULB AND ANY BATTERIES.**

### Terms and Conditions

1. The appliance must be installed by a GAS SAFE registered person.
2. The appliance must be used in accordance with the user's instructions.
3. The appliance must be serviced annually by a GAS SAFE registered person.
4. The benchmark and service log must be correctly filled out and the record of annual services must be up to date and supported by receipts in each case.
5. This warranty is not transferable and relates to the original installation only.
6. The appliance has not been subjected to misuse or accident or been modified or repaired by any person other than the authorised employee or authorised representative of Charlton and Jenrick Ltd.
7. The registration form must be returned within 1 month of purchase.

**Technical Help Desk 01952 200 444**

**For gas emergency call Transco: 0800 111 999**

## Benchmark Scheme



Charlton and Jenrick Ltd is a licensed member of the Benchmark Scheme which aims to improve the standards of installation and commissioning of domestic heating and hot water systems in the UK and to encourage regular servicing to optimise safety, efficiency and performance. Benchmark is managed and promoted by the Heating and Hotwater Industry Council. For more information and the full code of practice please visit [www.centralheating.co.uk](http://www.centralheating.co.uk)

Please ensure that the installer has fully completed the Benchmark Checklist on the inside back pages of the installation instructions supplied with the product and that you have signed it to say that you have received a full and clear explanation of its operation. The installer is legally required to complete a commissioning checklist as a means of complying with the appropriate Building Regulations (England and Wales).

All installations must be notified to Local Area Building Control either directly or through a Competent Persons Scheme. A Building Regulations Compliance Certificate will then be issued to the customer who should, on receipt, write the Notification Number on the Benchmark Checklist.

This product should be serviced regularly to optimise its safety, efficiency and performance. The service engineer should complete the relevant Service Record on the Benchmark Checklist after each service.

The Benchmark Checklist will be required in the event of any warranty.

It is a requirement that the gas fire is installed and commissioned to the manufacturer's instructions and the data fields on the commissioning checklist completed in full.

To instigate the guarantee, the gas fire needs to be registered with the manufacturer within one month of the installation.

To maintain the guarantee, it is essential that the gas fire is serviced annually by a Gas Safe registered engineer. The service details should be recorded on the Benchmark Service Interval Record and left with the householder.

## Introduction 800 HD B.F. with UBL USERS INSTRUCTIONS

The 800 HD BF with Under Bed Light has been designed and tested to the requirements of EN 613 and is suitable for use in Great Britain & Republic of Ireland.

800 HD BF with UBL incorporates a single gas valve which selects ignition pilot, with variable setting between low and high setting and is operated via remote control hand device or optional smart app device. This system is powered by mains electricity via pre-wired transformer plus supply cord. Alternative power supply is available for users during mains interruptions.

### Consumer Protection Information

As manufacturers and suppliers of heating products, we take every care to ensure that the design and construction has to meet the general safety requirements when properly used and installed. To this end, our products are thoroughly tested and examined before despatch.

Any alteration that is not approved by the manufacturer could invalidate the approval of the appliances, operation of the warranty and could affect your statutory rights.

This appliance could contain some materials that could be interpreted as being injurious to health. It is the users / installers responsibility to wear protective clothing when handling the following materials. Artificial fuel, mineral wool, insulation material, refractory/ceramic fibres and glass yarn. May be harmful if inhaled, may be irritating to skin, eye, nose and throat.

When disposing refractory / ceramic materials to keep dust to a minimum these materials should be securely wrapped in polythene and clearly labelled "RCF waste". These materials are not classified as hazardous waste and should be disposed of at a site licensed for disposal of industrial waste.

#### **Important**

For future reference we suggest you record the following details here, and keep the receipt as proof of purchase. This information may be asked for when you contact the helpdesk.

<b>MODEL:</b>	<b>INFINITY 800HD BF UBL</b>	<b>Serial No.</b>	
---------------	------------------------------	-------------------	--

This information can be found on the label attached to the packaging and on the data badge, which is located on the base of the appliance behind the control cover.

<b>Retailer Name:</b>	
<b>Address:</b>	
<b>Date Of Purchase:</b>	

#### **Installer information required to register for the extended warranty**

<b>Name:</b>	
<b>Date of installation:</b>	
<b>Gas safe number:</b>	

## Important Information (users instructions)

### Consumer protection information

As manufacturers and suppliers of heating products, we take every care, as far as is reasonably practicable, that these products are so designed and constructed as to meet the general safety requirement when properly used and installed. To this end, our products are thoroughly tested and examined before despatch.

**IMPORTANT NOTICE:** Any alteration that is not approved by the appliance manufacturer could invalidate the approval of the appliance, operation of the warranty and could affect your statutory rights.

### Health and safety notice

#### Important

This appliance could contain some of the materials, indicated below, that could be interpreted as being injurious to health and safety. It is the users / installers responsibility to ensure that the necessary personal protective clothing is worn when handling these materials, see below for information.

**Artificial Fuels, Mineral Wool, Insulation Material, Refractory/Ceramic Fibres, Glass Yarn** - *may be harmful if inhaled, may be irritating to skin, eyes, nose and throat.*

**When handling** *avoid inhaling and contact with skin or eyes. Use disposable gloves, facemasks and eye protection. After handling wash hands and other exposed parts. If a vacuum is used for cleaning the coals or cleaning after servicing / installation it is recommended that it be of the type fitted with a HEPA filter.*

**Disposal of refractory/ceramic materials.** *To keep dust to a minimum these materials should be securely wrapped in polythene and be clearly labelled 'RCF waste'. These materials are not classified as 'hazardous waste' and should be disposed of at a site licensed for the disposal of industrial waste.*

## INTRODUCTION

- The INFINITY 800 BF is an inset room sealed decorative fuel-effect gas appliance.
- The INFINITY 800 BF is available in **Natural Gas only**.
- The INFINITY 800 BF **must not** be installed into a natural draught flue or chimney.
- The INFINITY 800 BF should only be installed and serviced by a competent person i.e. GAS SAFE registered, in accordance with the GAS SAFETY (INSTALLATION AND USE) REGULATIONS.
- The INFINITY 800 BF does not require a chimney, but **must be** installed against an outside wall.
- It is important that the flue terminal is regularly checked and kept clear at all times.
- If the terminal is accessible to people (i.e. less than 2m above a walkway, balcony etc.) the terminal guard must be fitted to prevent access to the flue outlet, which becomes hot when the fire is in use.
- As the INFINITY 800 BF is a room sealed appliance (i.e. air for the combustion process is taken from outside the room) no purpose built ventilation is required.
- The INFINITY 800 BF is designed and tested to meet the requirements of the European Standard EN 613.

800 HD B.F. with UBL USERS INSTRUCTIONS

Lighting the Appliance & General Operation of Control

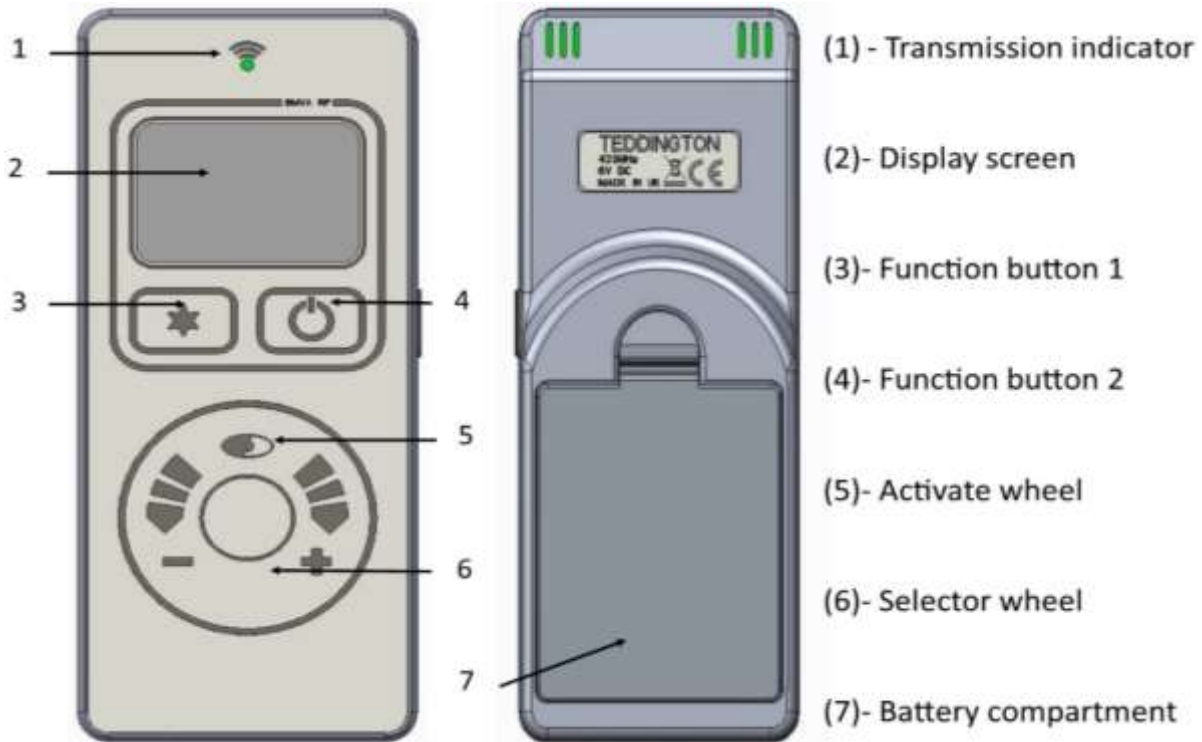

Handset set up video

<http://www.charltonandjenrick.co.uk/handsetguide/>



When inserting the batteries, observe and position batteries according to the battery compartment graphics (see Fig 7). When the batteries are inserted the handset will attempt to pair.



Fig 7 Battery compartment

**Display overview**

Press to awaken the handset from its dormant sleep mode at any time. Fig 1 shows the display neutral, ready to turn on.

**Turn on (start up).**

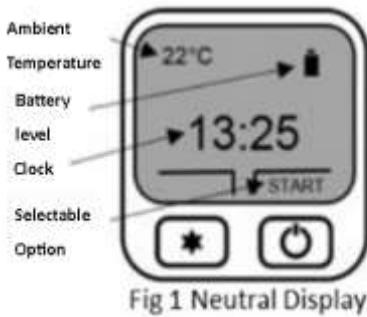

Pressing and holding displays an “UNLOCK” graphic Fig 2 prompting the button to be pressed simultaneously. Whilst both & are pressed a progress bar Fig 3 will complete. If either button is released before the progress bar has completed the operation will cancel. Once the progress bar has completed the handset will display the status of the fire (priming – ignition – pilot – main burner) finishing at the fire “on” display screen Fig 4.





### Flame height adjustment

Once the fire has been started (after a period of 10 minutes) the flame height can be decreased by moving your finger clock wise or decreased moving your finger anti-clock wise using the selector wheel. Once the desired flame level is set, remove your finger from the selector wheel to transmit your selection to the receiver. Six flame levels are selectable. Press  whilst the display is active to display the current flame level.

### Turn off (shut down)

To turn the appliance off, press and hold down  until the progress bar has completed. If the  is released before the progress bar has completed the operation will cancel.

### Mode select

With the fire running on manual operation you can access three further “modes”. Press  for “mode”. Use the selection wheel to cycle through the three options, “Auto”, “Sleep” and “Light”. Press  to select “Auto” or “Sleep”

Sleep:- Use the selector wheel to choose from the available time range of 5 minutes to 1 hour 30 minutes. Once the desired countdown time has expired the appliance will turn off. By pressing the  button during the countdown will cancel the countdown timer if required.

Light:- Use the selector wheel and scroll to the “light” option. An appliance back light can be turned on or off by pressing the  button.

Note: The handset contains a sensitive temperature measurement device. To achieve the best thermostatic efficiency do not place the handset near the heat source, avoid covering, direct sunlight or near a draft or open window etc. Place the handset at a midpoint in the room or area being heated. Allow 5-10 minutes for the handset to stabilize if subjected to extremes of temperature.

## Auto (Thermostatic) Control

Press  to awaken the handset from its dormant sleep mode at any time.

### Selecting auto control

The "auto" function can only be selected once the appliances has been started and initiated into "manual" mode. Once in manual mode, press and release the  button to enter the "mode" options. Auto is the first option, press to enter auto mode.

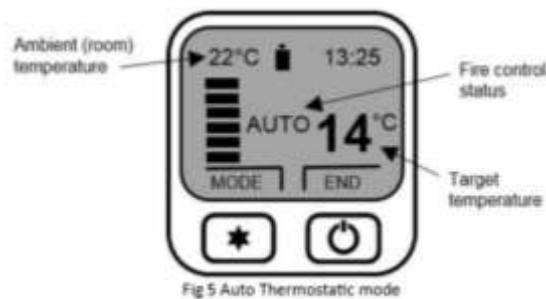

### Adjusting target temperature



Use the selection wheel to increase or decrease the temperature to the desired level, release your finger from the wheel to transmit the target temperature (See Fig 5) to the receiver. The "auto" function will now modulate the flame height to achieve your target temperature. The selectable temperature range is 1 degree C to 29 degree C.

### Cancelling auto function

Press  to "end" and cancel the "auto" control. The handset will return to manual control.



## Menu features

The menu can be accessed by pressing and holding the  button (approx. 5 seconds) until the menu graphic completes (see fig 6). Use the selector wheel to highlight one of the available options. Press  to enter the required option.

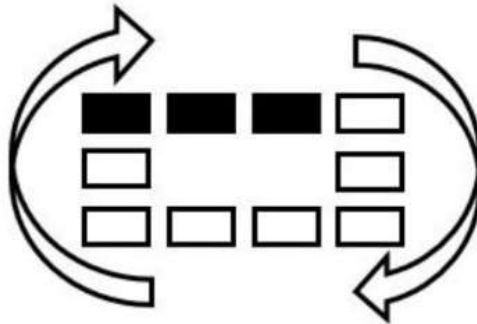





Fig 6 Menu Graphic



### Set clock

The handset clock has a dedicated 24 hour display. Use the selector wheel to firstly set the hours. Press  to change to minutes select. Use the selector wheel to change the minutes. Press the  button to alternate hours and minutes to make any other alterations. Finally, press the  button to save the clock setting.

### Display

Temperature display units-use selector wheel to select either Celsius (degree C) or Fahrenheit (degree F). Press the  button to save selection.

### Gas fire (pair code)

The device screen displays the current operating channel of the handset. To delete the channel press  &  simultaneously or  to return to the menu option.

### Reset

To restore the handset back to its original factory setting select "reset" from the menu options. Press - & - simultaneously to complete the reset command – to return to the menu options.

## Under Bed Light Feature

The Under Bed Light feature offers multiple lighting features to enhance a flame effect or provide lighting effects whilst the appliance heat output is not required.

The Under Bed Light feature can be operated whilst the fire is on or off.

Press  to awaken the handset from its dormant sleep mode at any time.

The Under Bed Light effects can be accessed in three operating modes:

### Access

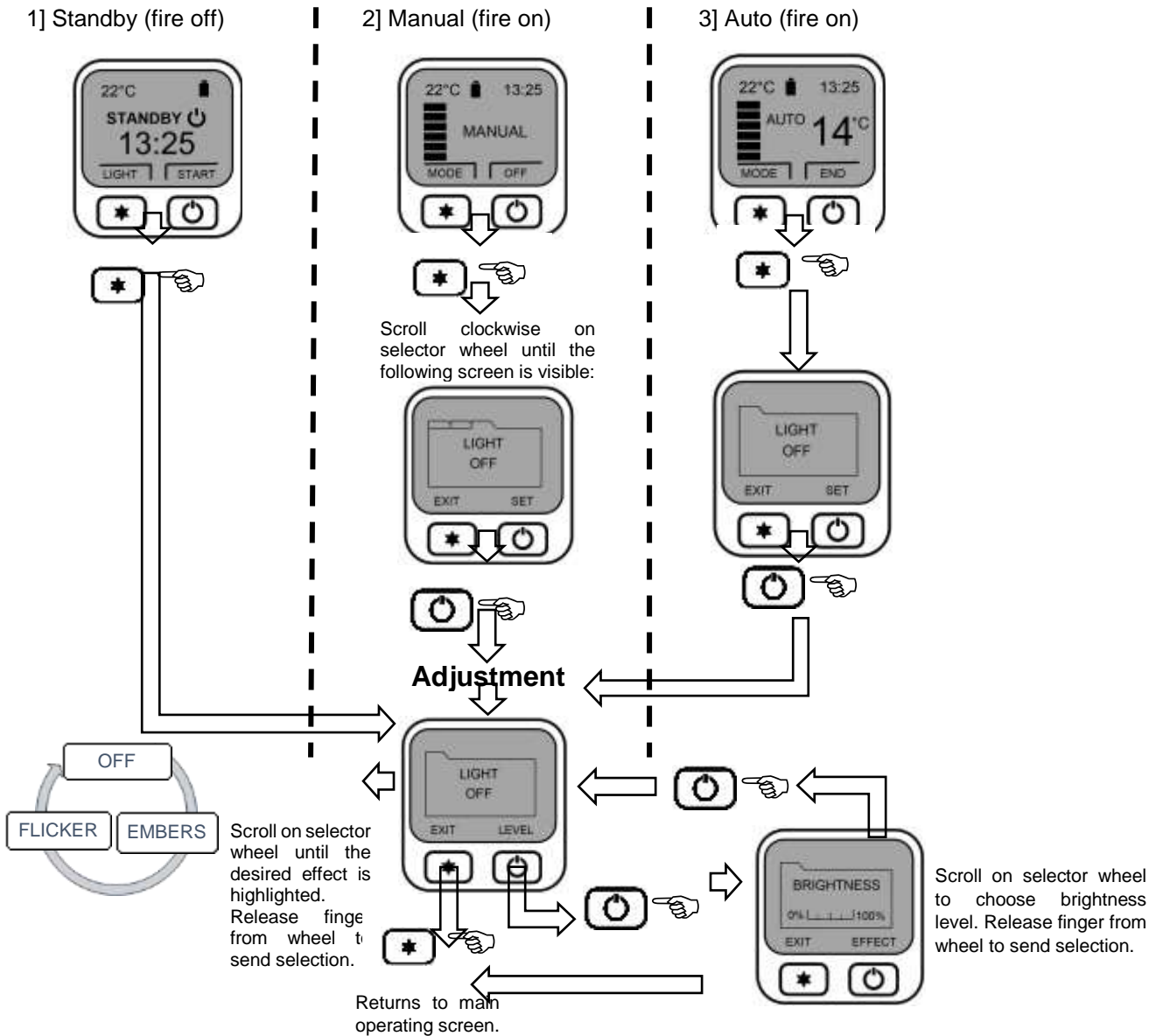

Notes:

- If no command is entered within 15 seconds whilst in the 'LIGHT' function the handset will return to the main operating screen.
- Brightness alternative on/off switch. 0% = lights off, any value greater than 0% will turn lights on for the effect selected. From 'light off' screen increasing brightness will turn backlighting on using last used effect.
- Brightness range feature is only effective in embers lighting effect.
- Turning the appliance off from a lit condition will turn Under Bed Light off also.

## Changing the Handset Batteries.

The handset operates from four AAA 1.5V batteries. New alkaline batteries are recommended. Do not mix new and old batteries. When inserting the batteries, observe and position batteries according to the battery compartment graphics (see Fig 7). When the batteries are inserted the handset will attempt to pair.



Fig 7 Battery compartment

## Cleaning & Laying the fuel bed (users instructions)

**Warning:-** Before you clean any part of the appliance ensure that the appliance is switched off and cool.

### **CLEANING: BLACK PAINTED SURFACES**

- These surfaces should be dusted regularly and any marks removed with a soft cloth.
- Abrasive or chemical cleaner should never be used.

### **CLEANING: GLASS PANEL**

From time to time it may be necessary to clean the glass panel.

We recommend you use a Ceramic Hob Cleaner (brands such as **HOB BRITE** and **VITRO CLEN** have been found to be **acceptable**) these are available from most leading Supermarkets.

Remove the glass panel as follows:-

- Carefully lift up and out the inner frame.

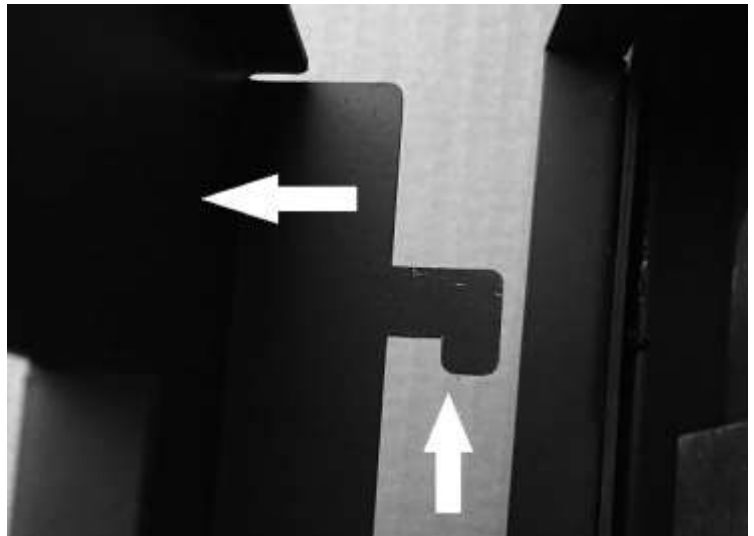

- Remove the three fixing brackets located on the top and sides of the glass panel.
- Remove the 4 x nuts on each of the Glass Clamps leaving the top Clamp till last, remember to hold the Glass Panel back when removing the nuts.

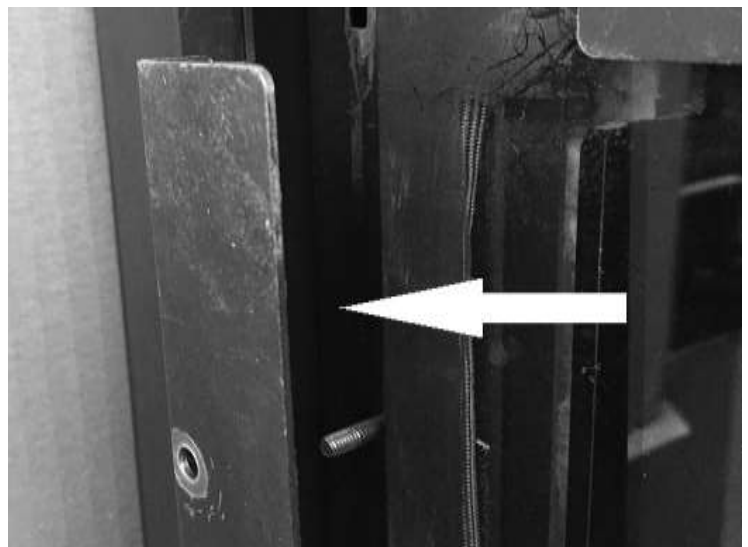

- Carefully lift the glass panel up out off the bottom location. Lay the glass panel down on a flat working surface on top of an old opened newspaper with the side to be cleaned uppermost.

**Follow the Instructions on the Hob Cleaner Bottle.**

On stubborn stains (where the appliance has been used for a long period without glass panel being cleaned), use a new **Brillo Pad** well wetted with the Hob cleaner applied directly to it.

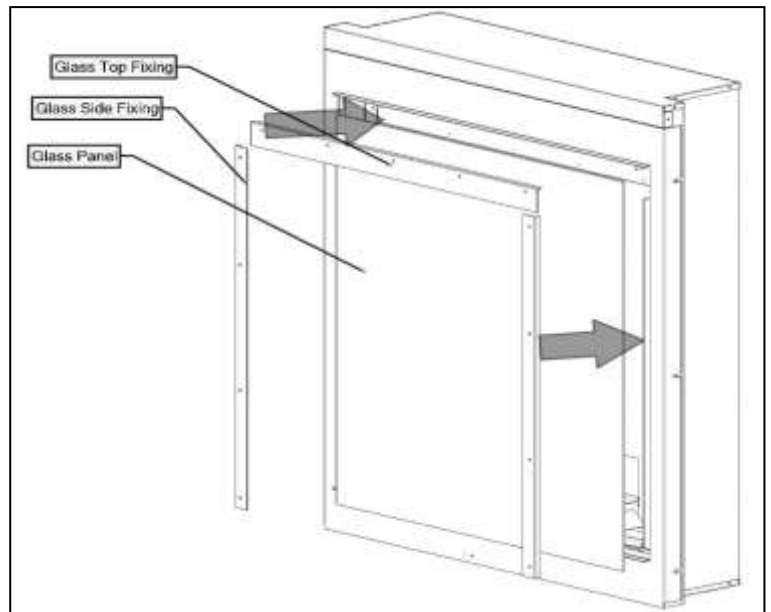

Ensure all the residues of the cleaner are removed with a damp cloth and the glass panel is completely dry before fitting to the appliance.

Note: - If the loose shapes have not been placed correctly, causing the gas flame to contact the glass this may result in glass staining that cannot be removed by cleaning.

- Re-assemble in reverse order ensuring a tight seal against glass assembly.
- Take care not to over-tighten the glass fixing nuts as this will cause the glass to break. Glass is not covered by warranty
- Re-fit the Inner Frame.

## **CLEANING AND REPLACING fuel bed shapes**

**Important:** - Refer to the 'Health & Safety Notice located on page 3 of this booklet before cleaning or replacing any refractory material.

Use only the shapes provided **NO OTHER SHAPES SHOULD BE ADDED** to the appliance

### **The Fuel bed set consists of:**

- 6 Log Shapes + LH & RH Finger Shapes.
- 1 Bag of Forge Embers
- 1 Bag of Glass
- 1 Packet of Embaglow

### **Log Fuel Bed Layout.**

Within this packed appliance is one packet of Ember glow. Only half of the packet should be used per install, the spare half of the pack is provided for the first annual service. Failure to place the correct amount of flakes and in the correct burner area can result in producing a poor flame picture and sooty deposits.

- Fit Airtray by sliding it in from the front and seating it so it sits flat onto the Tray sump
- Ensure that the Light Deflector plate is fitted correctly before commencing the Fuel Bed Layout.
- Place some of the Glass Chippings loosely at the rear of the burner, up to the height of the burner but not over it, as shape No.1 has to fit flat on the tube. Avoid placing the chippings too far forward at this stage, as shape No.2 has to fit at the front, as shown below.

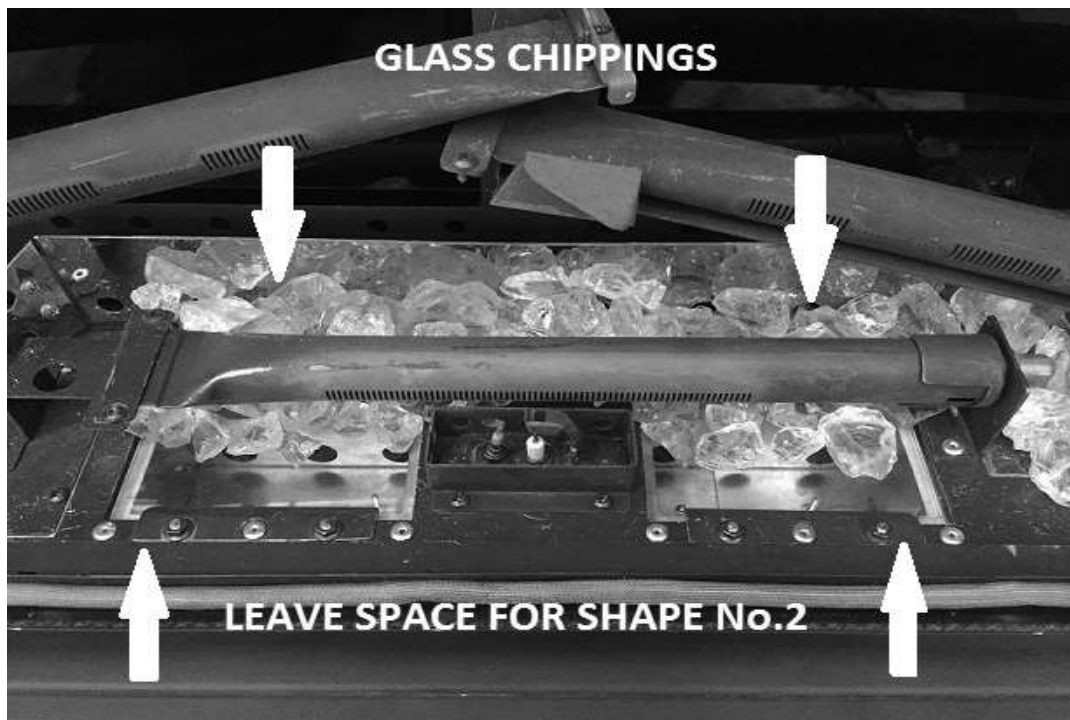



## 800 HD B.F. with UBL USERS INSTRUCTION

Place shape No. 1 on the burner tube, so that the wings on the shape fit over the burner support bracket on the left hand side pushing it to the right hand side once on the bracket, making sure it sits flat on the burner tube.

- Avoid getting any of the Glass Chippings towards the front as another shape has to fit there.

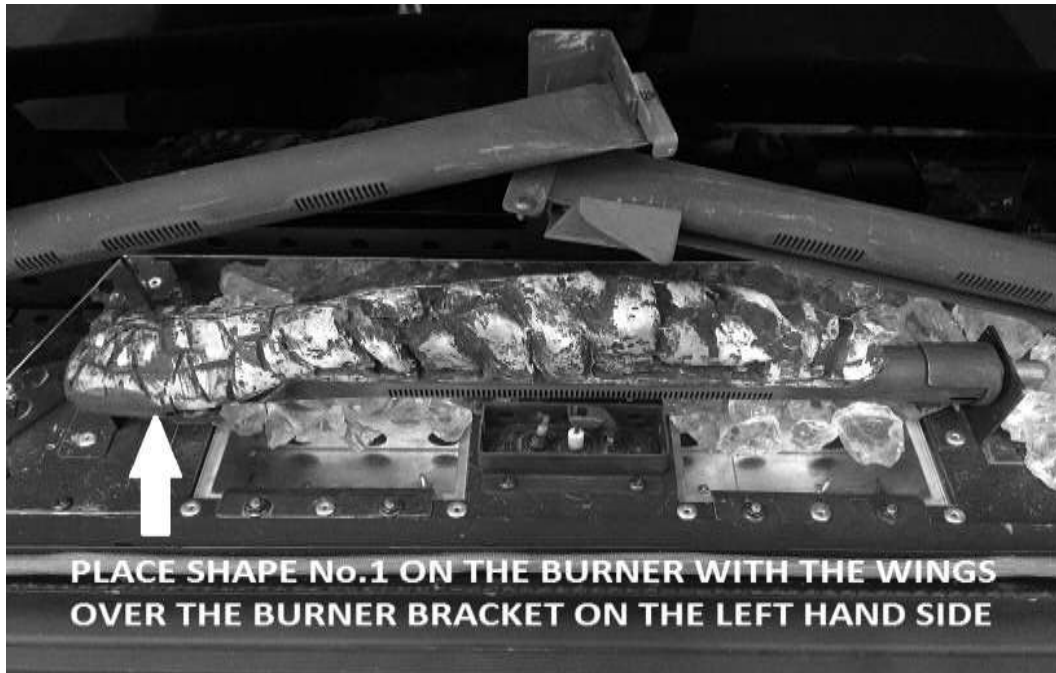

- Place the LH and RH finger shapes on the angled ends of the Light Deflector Plate and push them towards the back as shown.
- Place a few of the Forge Embers on top of the Glass Chippings at the rear and sides filling any voids for decorative effect.

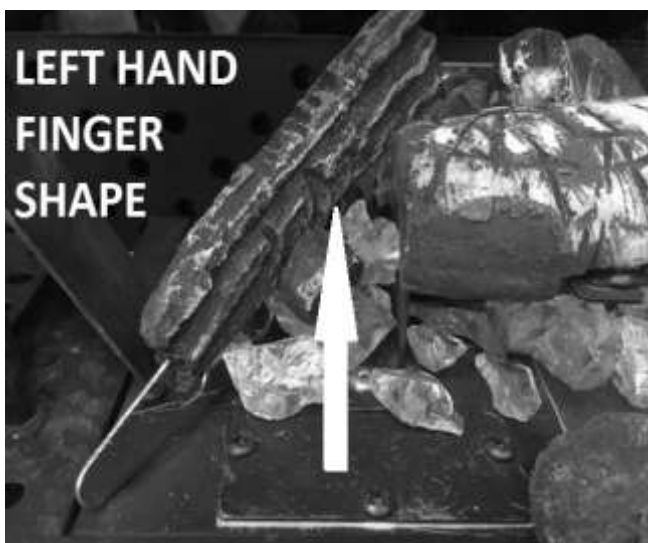

## 800 HD B.F. with UBL USERS INSTRUCTION

- Place shape No. 2 at the front with the small grooves on the underside going over the nuts on the Light Box Glass clamps as shown. The shape should sit flat, now some more of the glass chippings can be added on top of the glass on the light boxes.

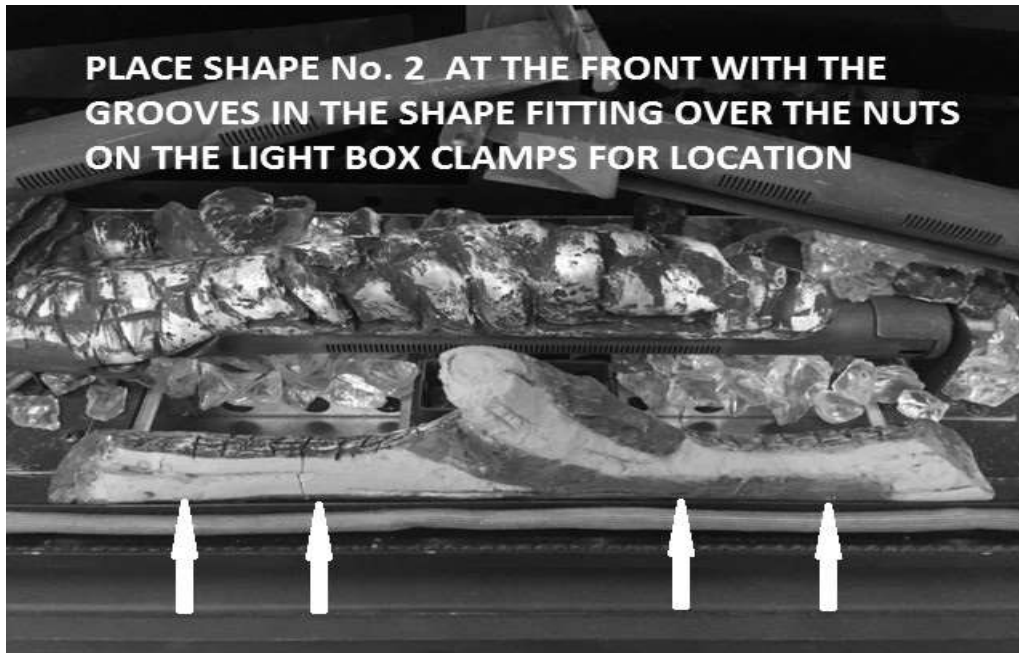

- Embaglow can now be added, take out just under half of the packet and tease it apart loosely to create a fine mesh as seen below.

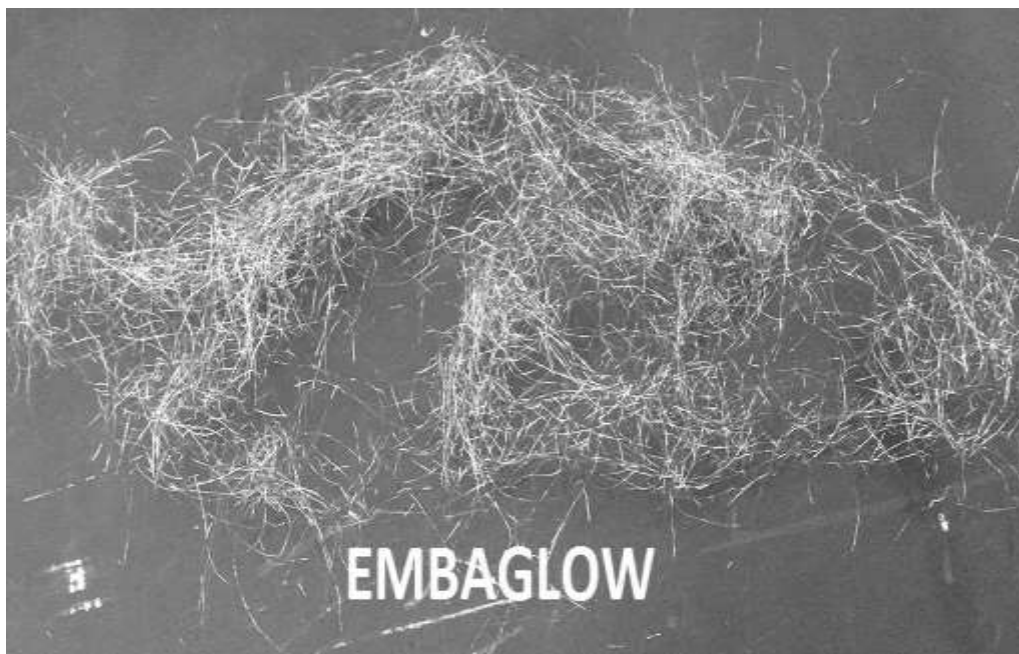

- Within this packed appliance is one packet of Ember glow. Only just under half of the packet should be used per install, the spare half of the pack is provided for the first annual service. Failure to place the correct amount of Embaglow in the correct burner area can result in producing a poor flame picture and sooty deposits.**



## 800 HD B.F. with UBL USERS INSTRUCTION

- Carefully lay the Embaglow on top of shape No.1 , so it just rests on top without any of the strands touching or falling on the Pilot area, **as this may cause ignition issues**, please see picture.



- Place shape No. 3 on top of the Right Hand burner pushing it to the Left, so it fits snug over the burner, make sure it sits flat and there are no Glass Chippings or Forge Embers underneath it.
- Place a few more Glass Chippings & Forge Embers on top of the light boxes, leaving a space at the front for the last shapes.

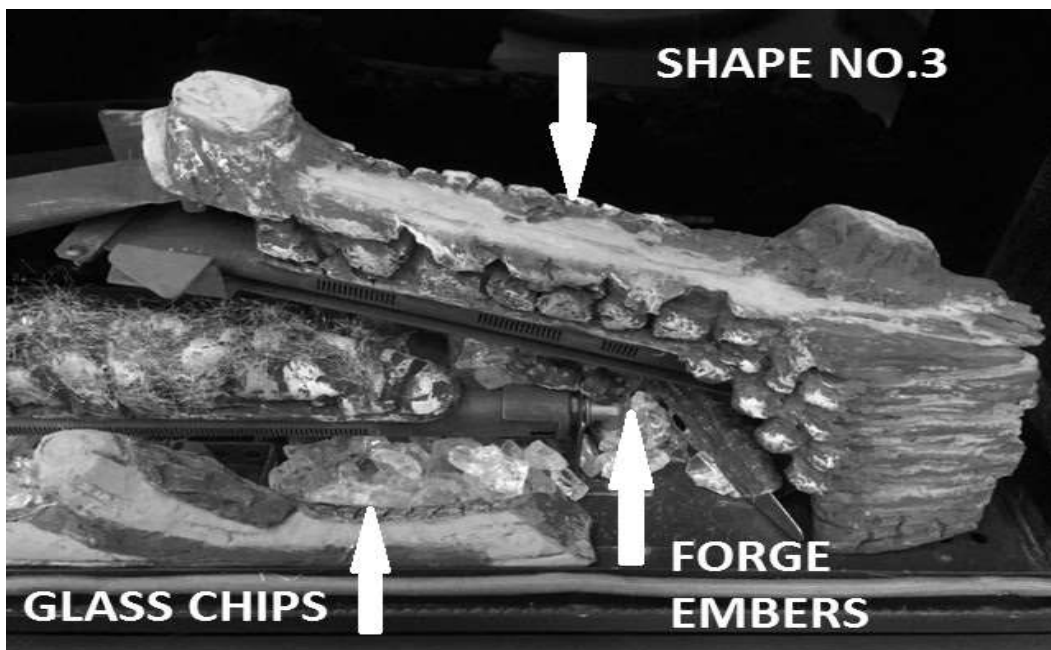

800 HD B.F. with UBL USERS INSTRUCTION

- Place shape No.4 on top of the Left Hand burner pushing it to the Right, so it fits snug over the burner, make sure it sits flat and there are no Glass Chippings or Forge Embers underneath it.
- Place a few more Glass Chippings & Forge Embers on top of the light boxes, leaving a space at the front for the last shapes.

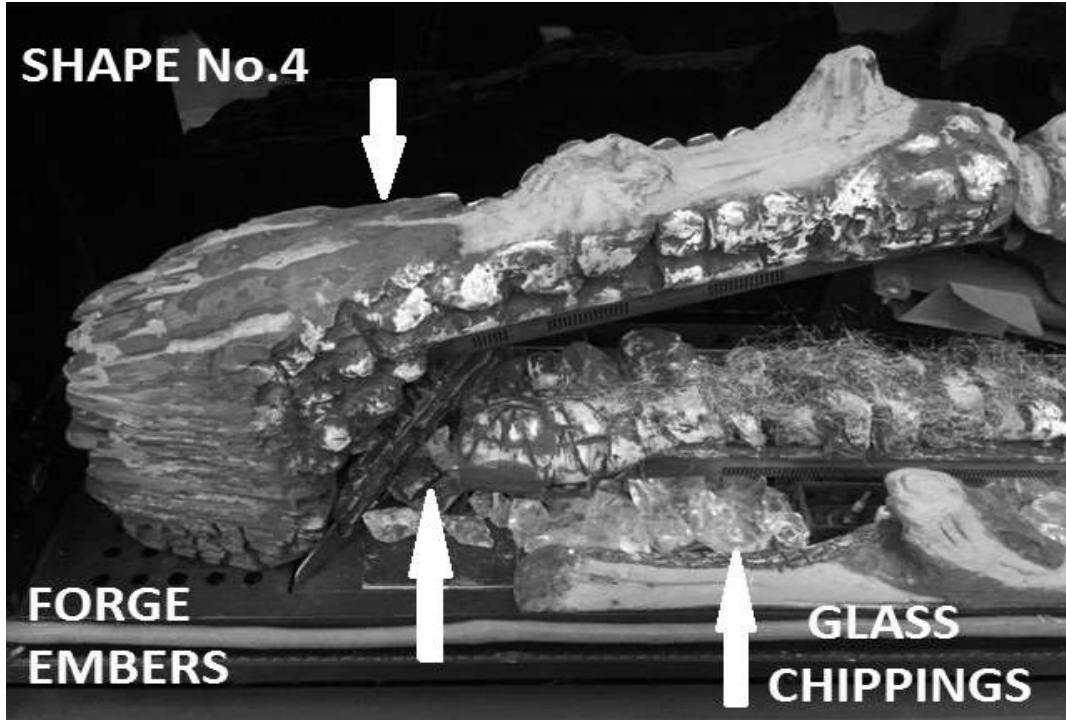

- Place shape No. 5 so it fits tight up against the front shape No.2 at the bottom so there is no gap, and rest the cut out underneath on the top on the Burner Support Bracket as shown.

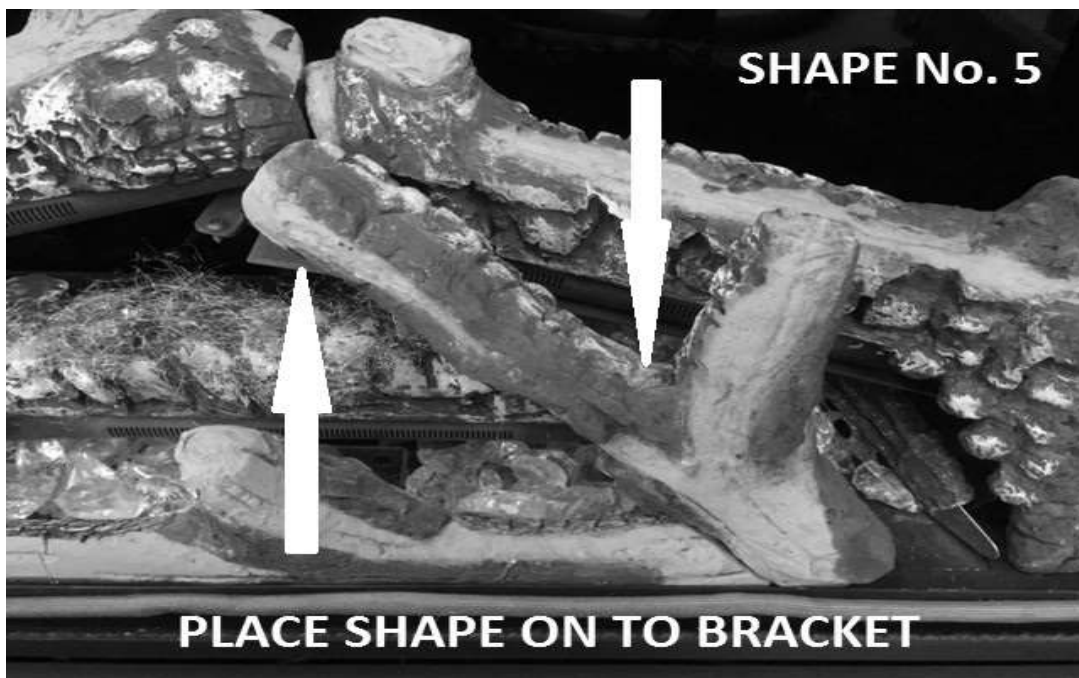

## 800 HD B.F. with UBL USERS INSTRUCTION

- Place shape No.6 so it sits tight up against the front shape No.2 at the bottom so there is no gap , and rest the cut out on the underside over the end of shape No.5

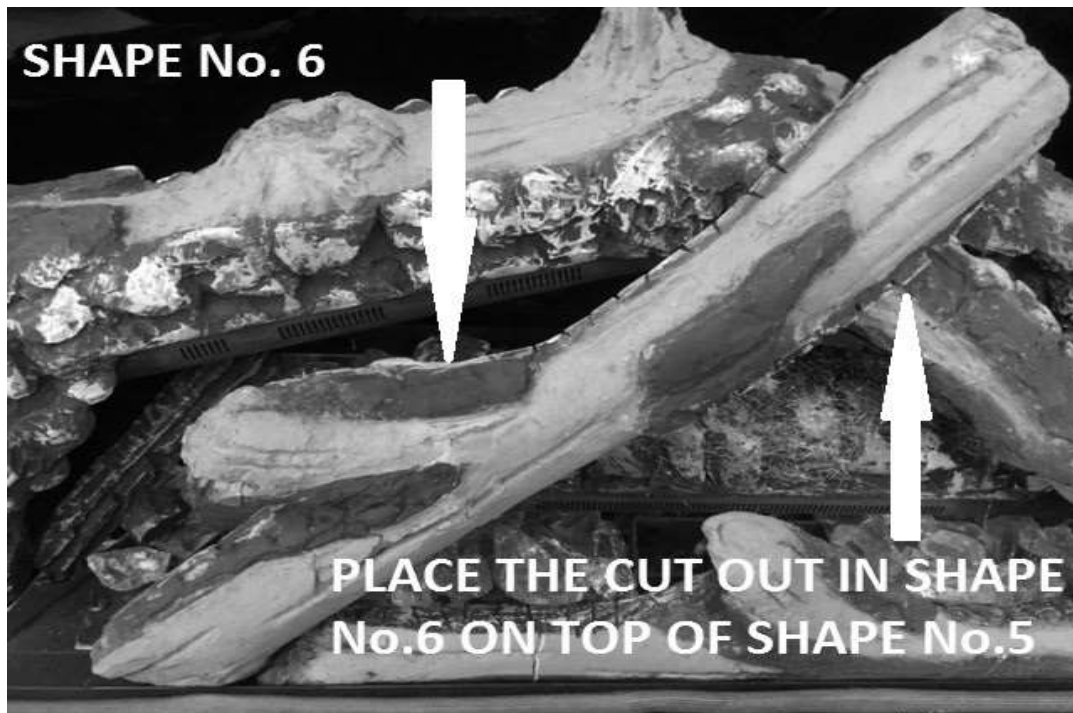

- Place the rest of the remaining Glass Chippings & Forge Embers, randomly over the Airtray and in any gaps to give a more natural look.
- When the last of the shapes have been fitted, make sure none of the Glass or Embers have fallen over the Pilot Assembly as this may cause ignition issues.

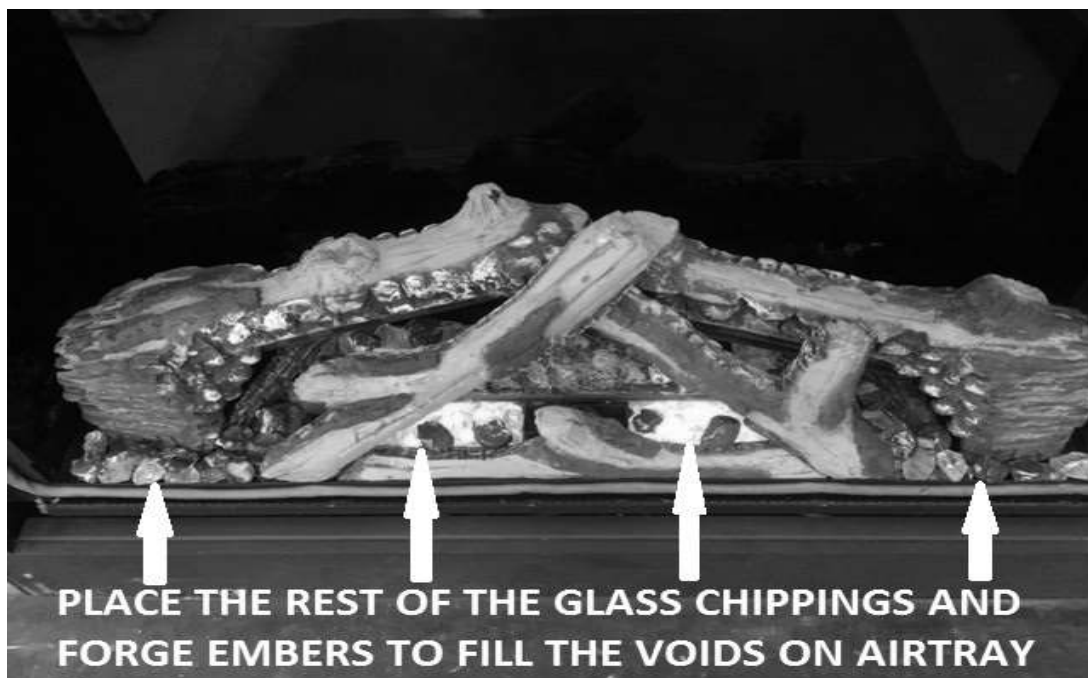



## Appliance Data (installation instructions)

Fire Box dimensions: ..... Height 1022mm

Width 813mm

Forward Projection: ..... 45mm

Weight: ..... 55kg

Flue Length.....100mm (minimum) to 600mm (maximum)

No bends or joined flue pipes should be used in the flue system.

Pressure Test Point Location: ..... Gas inlet elbow

Gas Connection: ..... 8.0mm O/D, tube.

Data Badge Location: ..... On bottom right hand side of firebox behind trim.

MODEL	Natural Gas (G20) Version
Category of appliance	C <sub>II</sub>
NO <sub>x</sub> Class	4
Efficiency Class	1
Gas Category	I <sub>2H</sub>
Gas Type	G20 Natural Gas
Gas Pressure +/- 1.0mbar	20 mbar
Gas Input (Max)	7.2 KW Gross
(Min)	3.8 kW Gross
Injectors size Middle	MK140 Mark
Side	MK220 Mark

**NOTE:** The efficiency of this appliance has been measured as specified in BS EN613-2001 and the result is 76.5 % natural gas. The gross calorific value of the fuel has been used for this efficiency calculation. Gastec have certified the test data from which it has been calculated. The efficiency value maybe used in the UK Government's Standard Assessment Procedure (SAP) for energy rating of dwellings.

### **SECTION SIX Regulations and Warnings (installation instruction)**

- This appliance must only be installed in Great Britain or Ireland.
- The appliance is available in natural gas only.
- This appliance must be installed on a suitable outside wall.
- No special ventilation bricks or vents are required into the room containing the appliance.
- **In GB (Great Britain)**

It is the law that all gas appliances must be installed by a competent person; i.e. a GAS SAFE registered installer, in accordance with the current Gas Safety (Installation and Use) Regulations (as amended), all relevant parts of the local and national building regulations and all relevant recommendations of the current British Standards. Failure to do so could lead to prosecution.

The following are the relevant codes of practice and British Standards: -

B.S. 5871 PART 2

B.S. 5440 PART 1

B.S. 6891

B.S. 1945

Note:- This appliance must be installed to current versions of the above standards and include any relevant amendments.

The Building Regulations issued by The Department of the Environment.

The Building Standards (Scotland) (Consolidated) Regulations issued by The Scottish Development Office.

- **IN IE, (Ireland)**

The appliance must be installed by a competent person and installed in accordance with the current edition of I.S.813 Domestic Gas Installation, the current building regulations, and the current ETCI rules for electrical installation, if appropriate.

### **WARNINGS**

- As this appliance has components, which get very hot as with all such fires, it is recommended that a fireguard should be used for the protection of children, the elderly, or the infirm. Fireguards should conform to B.S.6539 (1984) (Fireguards for use with solid fuel appliances).
- During initial use, an odour may be evident. This will soon disappear if the fire is run on its maximum setting for a few hours.
- Care must be taken to prevent any damage being caused to surrounding soft furnishing or decoration, e.g. wall coverings may become discoloured if placed too close to the appliance.
- To reduce heat transfer to the surround it is recommended that the header is packed with "Rockwool"

## 800 HD B.F. with UBL INSTALLATION INSTRUCTION

### Siting the Appliance (installation instructions)

#### **GENERAL REQUIREMENTS**

- The flue and air duct length must be between 100mm to 600mm.
- The fire is supplied with a standard pipe length of 600mm.
- The flue and air duct must not have any bends.
- The flue outlet must terminate on a suitable outside wall.
- The minimum flue terminal clearances, which must be maintained, are as shown below.

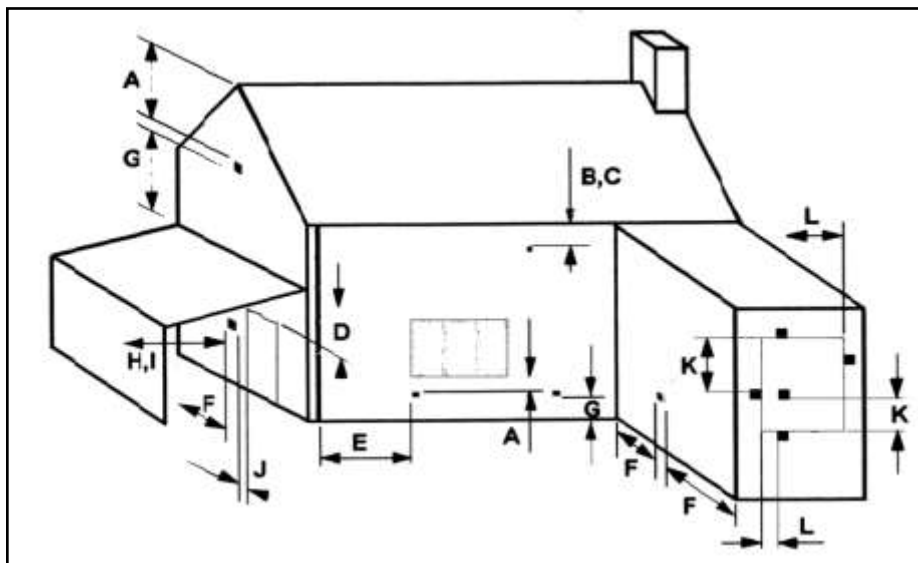

A. Directly below an openable window or other opening. E.g. air brick.....	300mm
B. Below gutters, soil pipes or drain pipes.....	300mm
C. Below eaves.....	300mm
D. Below balconies or carport roofs.....	600mm
E. From vertical drain pipes and soil pipes.....	75mm
F. From internal and external corners.....	300mm
G. Above ground, roof or balcony level.....	370mm
H. From a surface facing the terminal.....	600mm
I. From a terminal facing the terminal.....	1200mm
J. From an opening in a car port into a dwelling e.g. door, window, etc.....	1200mm
K. Vertically from a terminal on the same wall.....	1500mm
L. Horizontally from a terminal on the same wall.....	300mm

**Please note :- The minimum depth requirement may well be difficult to obtain. This could result in the need for the firebox to be spaced further from the internal surface of the plaster and to achieve this larger rebated surround maybe necessary.**

## 800 HD B.F. with UBL INSTALLATION INSTRUCTION

Ensure that gas supply is suitably sited

- Check with the supplier or manufacturer that the surround meets 150°C minimum rating (attention should especially be given to manmade materials such as resin).
- **To minimise the risk of cracking due to heat expansion the use of a 3 – piece back panel is recommended.**

### **Clearance to Shelf**

Minimum clearance from hearth or base of opening to underside of combustible shelf should be 1075 mm provided the shelf depth is 75mm (3"). This gives a minimum clearance above the appliance of 140mm. For a shelf of 150mm (6") the minimum height above the hearth or base of opening must be 1265mm. This will give a minimum clearance above the appliance of 250mm.

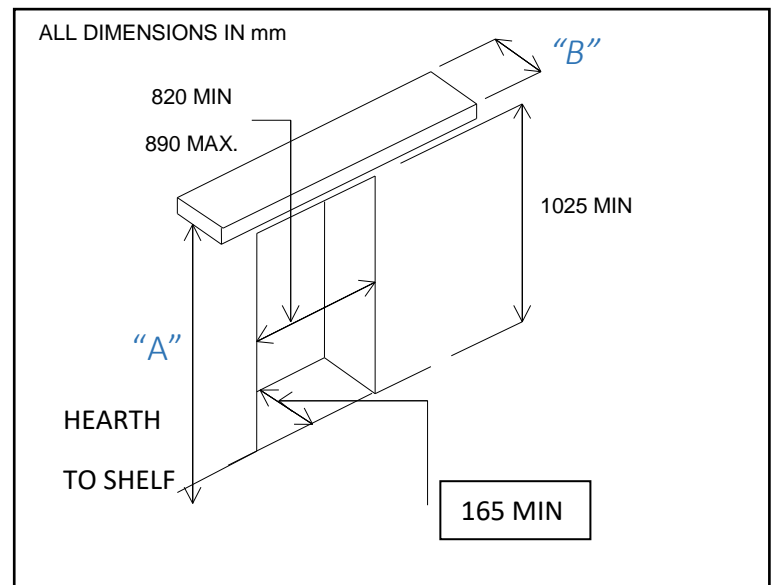

### **Clearance to Sides of Fire**

Minimum width between vertical sides of combustible surround should not be less than 890 mm provided fire is central to the surround and sides do not project more than 150 mm. When vertical side forward projection is increased by 12.5 mm add 50 mm to inside width of surround.

## **Preparing the Appliance for Installation (installation instructions)**

Carefully unpack the appliance from the carton and check the contents.

- Lift away the Box of ceramics, glass panel and Fire frame components.
- Remove the refractory components from the inside of the packaging.
- The appliance is now ready for installation.

**INSTALLING THE APPLIANCE INTO CAVITY WALL** Ensure it is a suitable outside wall constructed of non-combustible materials and that the flue position meets the requirements previously described in Section 8.

- Before cutting out any opening, check at what height the opening needs to be, with regards to any surrounds that the fire is going to be fitted into, as the heights of Hearths and Bottom Slips can vary.
- Mark a vertical line on the wall at the intended centre of the appliance up from the horizontal base of the opening to the top horizontal of the opening 1030mm.
- If inseting into the wall, mark the position for a `intel` above the top horizontal line.
- Mark up Flue centre measurement of 861mm.
- Using a long masonry drill, make one pilot hole completely through the wall. Ensure the hole is drilled accurately at the centre and square to the wall both horizontally and vertically at the cross points previously marked.
- If inseting into the wall proceed as follows: Cut out the brickwork of the inner skin of the cavity wall for the lintel, and fix the lintel.
- Cut out the brickwork under the lintel, between the two outside vertical lines into the cavity. Ensure the cut out width is square and try the appliance into the opening.

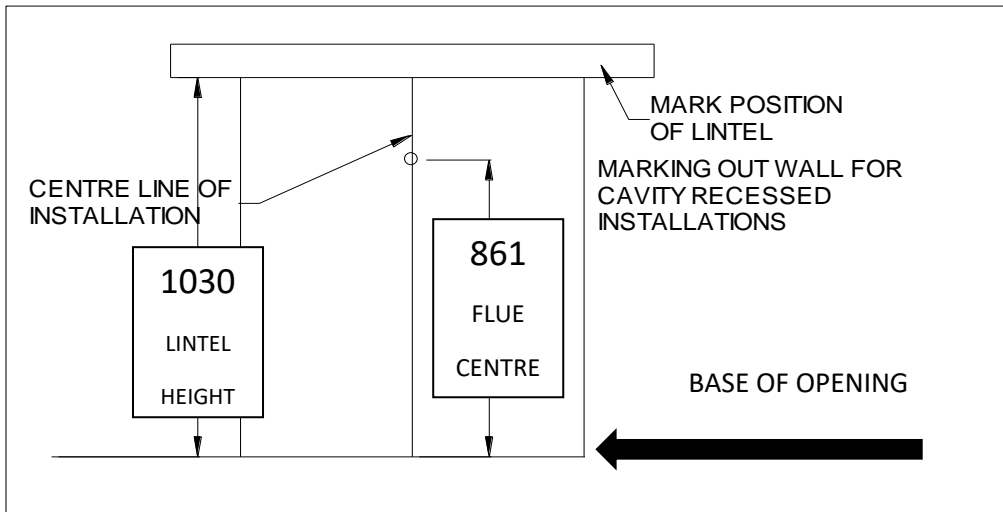

Using 150mm core drill cut a hole following the pilot holes. Drill from the outside through to the cavity to give a good finish on the outside.

- Remove any cavity insulation from the cut out opening and for a further 100mm into the cavity gap each side and above.
- Pack “Rockwool” around the sides and top of the opening into the cavity for a depth of 100mm. Also put some behind the firebox if space is available.
- Offer the appliance into the opening and mark through the gas pipe entry hole (see connecting the gas supply section).
- Pass a tape measure through the core-drilled hole and record the distance from the back of the fire to the outside wall
- Cut the outer tube to the recorded length. Add 25mm to this measurement to determine the length of the inner tube and cut to size. **NOTE: The inner tube will be 25mm longer than the outer tube**
- Remove the appliance from the opening, and position the gas supply (see connecting the gas supply later in this manual), taking account of the relative gas regulations regarding a gas pipe in a cavity (sleeving and sealing etc). Note the gas feed must be fitted with the isolation valve supplied.
- Push the appliance back into the opening and fill any space behind the appliance with “Rockwool”.
- Complete the gas connection (see connecting the gas supply later in this manual).
- Drill the four fixing holes through the hole in the flange of the appliance and fix back using plug and screws.
- If the flue outlet is fitted below 2m from the floor or a balcony then the flue terminal guard must be fitted.

Packaging Check List
1 x Glass Panel
1 x Boxed Fuel Bed
1 x Transformer Plug
1 x Battery Holder
1 x Emergency Power Battery Adaptor
1 x RF Handset
4 x AAA 1.5V Batteries



## Connecting the Gas & Power Supply (installation instructions)

**TURN OFF ANY GAS APPLIANCES THAT ARE FED BY THE METER AND ISOLATE THE GAS SUPPLY BY TURNING OFF AT THE METER.**

- **The Gas & Power supply must be assessed at this stage.**
- For ease of installing the Gas Supply , the front outer frame can be removed by undoing the 6 x screws on the sides and lifting the fame upwards and outwards.
- The Gas Connection can be made by removing the gas inlet cover located on the left hand side of the fire box sump assembly.
- Remove the middle burner tube, by undoing the 2 x screws on the burner bracket and lifting away.
- Remove the 8 off fixing screw and remove the plate plus gasket. **Please note special attention should be taken not to damage the gasket.**
- You will then have access to the isolating cock which is fitted in the supply feed.  
The appliance is supplied with a factory fitted isolation device to allow for an 8mm copper connection. No further isolation point is required.
- **THE GAS INLET ISOLATION DEVICE MUST BE ANGLED TO ALLOW ACCESS TO THE GRUB SCREW AND GAS TEST NIPPLE.**
- When a concealed gas fitting from the rear is required it is necessary to route the pipe to the left side of the unit, taking into account the requirements of BS 6891 1988 dealing with enclosed pipes.

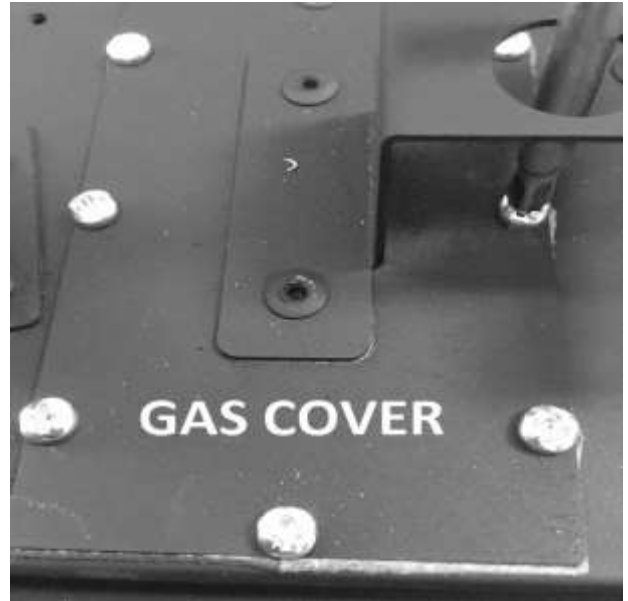

When installing the firebox into a cavity wall, any part of the installation pipe work installed in the void open to the cavity wall must be enclosed in a gas tight sleeve. It must be sealed at the point at which the sleeved installation pipe enters the fire (The Gas Safety (Installation and Use) Regulations Certificate of exemption number 1 of 1996). Where the pipe enters the fire the outer sleeve must be sealed to the grommet and the pipe must be sealed to its outer sleeve using suitable mastic.

### **POWER LEAD ROUTING**

- The power supply for this appliance is provided via AC power adaptor 230 VAC. The main cable terminates at the rear middle of the fire box. The length of the cable provided with the appliance is 1.65 metres. Care must be taken when siting the fire box not to trap the exposed main cable within the builders opening.
- The cable can be routed by passing the cable through the side of the chimney breast. It is good practice to run the cable within a sleeve of at least 15mm internal diameter, sealing the sleeve using a suitable sealant at the point the sleeve / cable terminates the chimney masonry.
- With power points that exceed the 1.65 metre distance, an optional 2.0 metre extension cable is available Part No 7147.
- The battery manual override option is a backup supply in case of a power failure / power cut to the property. The battery holder and adaptor lead are provide within the packing of the appliance. (Please note that the “C” cell batteries are not included). It is good practice to demonstrate the battery option to the customer during the commissioning process.

## 800 HD B.F. with UBL INSTALLATION NSTRUCTION

- The cable system consists of retro fitting plug sockets which offers the following options. (Please see below).

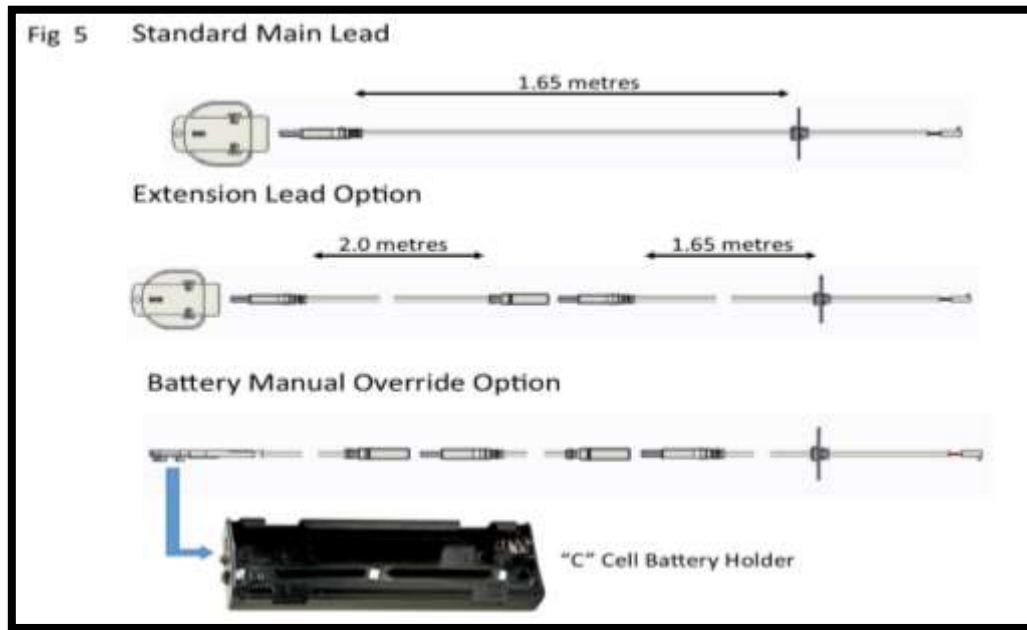

## Commissioning the appliance (installation instructions)

### CHECKING GAS SOUNDNESS AND RUNNING PRESSURE.

- Turn on the supply to the appliance and check for soundness in accordance with the current codes of practice.
- Turn off the gas supply at the external isolation valve.
- The Gas Isolation point grub screws must be at an angle which will allow the test point to be accessed from inside the fire, when the Gas Cover is removed.
- Remove the pressure test point screw from the inlet elbow
- Connect the pressure gauge by feeding the tube through the front grill so the gas cover and burner tube can be temporary fitted to do pressure test.
- Turn on the gas to the appliance at the isolation valve.
- Light the appliance as described in the user instruction section. Page 6 turn on (start-up).
- Check the inlet pressure is 20 mbar +/- 1.0 mbar with other appliances running.
- Turn off gas supply, at the isolation valve. Disconnect the pressure gauge and replace the pressure test point screw.
- Turn on the appliance and check the pressure test point for soundness with detection fluid.
- Refit the Gas Cover and Burner Tube as shown on page 25.

## Assemble the appliance (installation instructions)

- Refit the Outer Frame making sure the screws are securely tightened.
- Fit the Airtray by sliding it in from the front, making sure it sits flat on Tray sump.
- Fuel bed layout should be done using the guidance stipulated on pages 14 - 19 of the User Instruction section.
- Position the shapes components as described as it is important that the shapes are positioned exactly as described to ensure the correct operation of the appliance. Badly positioned shapes may result in the gas flame being driven forward onto the glass and permanently marking it.
- Taking great care, locate the glass panel within the gap between bottom retaining bracket and glass seal.
- When located push back against the seal and locate and tighten the three fixing brackets. (Please note over tightening the fixing nuts can result in damage to the glass panel) Glass is not covered by warranty.
- When assembly is complete please refer to pages 6 -10 for operation.

## Instruct and Advise the Customer (installation instructions)

- Demonstrate the lighting and extinguishing procedure to the consumer/user and the removal and refitting of the trim for cleaning.
- Explain that for the first few hours of the fire operating there will be an initial odour. This is due to the curing of the paint, the appliance should be operated on its high setting, and it is recommended that a window is left open until that odour has completely disappeared.
- Instruct on the glass removal and refitting.
- Instruct on the shapes cleaning and advise that a vacuum cleaner can be used but only after all the loose shapes have been removed. **Refer to 'Health & Safety Notice (See Section One) at the front of this booklet before proceeding.**
- Advise customer that with use the inside of the air box will change colour, particularly the sides and rear. This is quite normal and often adds to the overall effects of the appliance.
- Advise that the appliance should be serviced annually by a competent person i.e. a **Gas safe registered engineer** in accordance with these instructions.
- Although the appliance is fitted with a glass front which acts as a dress guard it is strongly recommended that a fireguard should be used for the protection of children, the elderly or infirm. Fireguards should conform to B. S. 6539 (1984) (Fireguards for use with solid fuel appliance).
- **Hand these instructions to the user.**

## Maintenance Instructions

### **General**

- Servicing should be carried out annually by a competent person such as a GAS SAFE-registered person in accordance with the relevant regulations, to ensure the safe and correct operation of the appliance.

**Warning: - Before commencing any service or replacement of parts, turn off the gas supply to the fire.**

- After servicing check for gas soundness.
- When ordering spare parts please quote appliance name and serial number these can be found on the data badge, which is located on the left hand side of the base of the appliance.
- If soot has accumulated check to establish cause, rectify and clean accordingly.

**Important: - Refer to 'Health & Safety Notice (See Page 3) at the front of this booklet before removing the fuel bed components.**

- Examine the shapes for signs of cracking and replace if necessary.(IMPORTANT) see shape layout procedure in section four of this manual before attempting to replace items, which should only be replaced as a complete set with no extra shapes added.

## Maintenance Instructions

**Before commencing any service or replacement of parts, turn off the gas supply to the fire.**

### **Removal of Burner Tray. \*\*\*\*\* A long Pozi Screw Driver will be required \*\*\*\*\***

1. Switch off the mains supply from the main supply plug socket.
2. Remove the Inner Frame by lifting up and outwards.
3. Remove the 3 Glass retaining brackets positioned on both sides and top of the glass panel.
4. Remove the glass panel.
5. Remove all of the Fuel Bed, Log Shapes, Glass & Forge Embers.
6. Remove the Left hand Burner Tube by removing the screw and retaining bracket.
7. Remove the Right hand Burner Tube by removing the 2 x screws and retaining bracket.
8. Remove the Middle Burner Tube by removing the 2 x screws and retaining bracket.
9. Remove the Light Deflector Plate, by removing the 2 x screws at the rear, a long Pozi Screw Driver will be required, and sliding out from the left.
10. Remove the Airtray and then the two rear inlet covers by removing the two outside screws.
11. Remove Gas Supply Cover and Isolate Gas at Restrictor Elbow and disconnect pipe.
12. Remove all the No 20screws fixing the burner sump to the firebox shelf. Lift the complete burner sump assembly up slightly ( Be careful not to damage the gasket, as a new one will be required, for reassembly).
13. With the sump assembly lifted out of the way, Disconnect the Power Lead from the Small LED Driver Board, Valve Motor wire, Ignition wire and Thermocouple interrupter wires from the E.C.U.
14. Replace in reverse order, turn on gas supply, check for soundness, correct operation and re-commission.

### **Replacement of Gas Control.**

1. Follow removal of Burner Tray (1 – 13)
2. Disconnect all the pipes and thermocouple from the Gas Valve.
3. Change, service or replace the valve and re-assemble in reverse order.
4. Re-assemble the complete tray into the fire in reverse order and re-connect all parts.
5. Turn on the Gas supply, check for soundness and recommission.

### **Replacement of Injectors.**

1. Follow removal (1 – 5).
2. Remove the left hand burner tube by removing the screw and retaining bracket.
3. Remove the Right hand burner tube by removing the 2 x screws and retaining bracket.
4. Remove the Middle burner tube by removing the 2 x screws and retaining bracket.
5. Undo the compression nut on the supply pipe.
6. Unscrew the locking nut holding the injector and silencer bracket on the burner carrier.
7. Remove injectors from assembly. Clean or replace injector.
8. Re-assemble in reverse order.

### **Replacement of the Thermocouple.**

1. Follow removal of Burner Tray (1 – 13).
2. Remove the Thermocouple from the rear of the Valve.
3. Disconnect the Thermocouple wires from the E.C.U.
4. Undo the Thermocouple nut from the pilot assembly, remove the Thermocouple and replace.
5. Replace in reverse order, turn on gas supply, check for soundness, correct operation and re-commission.

## Maintenance Instructions

### **Replacement of the Pilot Injector.**

1. Switch off the mains supply from the main supply plug socket.
2. Follow removal of Burner Tray (1 – 13).
3. Undo the pilot tube nut at the pilot bracket.
4. Pull the pipe gently back taking care not to damage pipe or olive hook nut.
5. Remove the pilot injector from inside the pilot bracket.
6. Clean or replace pilot injector.
7. Replace in reverse order, turn on gas supply, check for soundness, correct operation and re-commission.

### **Replacement of the EDB Unit.**

1. Switch off the mains supply from the main supply plug socket.
2. Follow removal of Burner Tray (1 – 13).
3. Remove the M3 nuts holding the E.C.U. to the base of the Fire Box.
4. Pull the E.C.U. up and remove all the wires & connections
5. Replace E.C.U. and reconnect all the wires
6. Replace in reverse order, turn on gas supply, check for soundness, correct operation and re-commission.

### **Replacement of the Under Bed Drive Board.**

1. Switch off the mains supply from the main supply plug socket.
2. Follow removal of Burner Tray (1 – 13).
3. Remove the M3 nuts retaining the UBL Drive Board to the base of the Fire Box.
4. Disconnect the three leads into the UBL Drive Board.
5. Replace in reverse order, turn on gas supply, check for soundness, correct operation and re-commission.

### **Replacement of the LED Strip.**

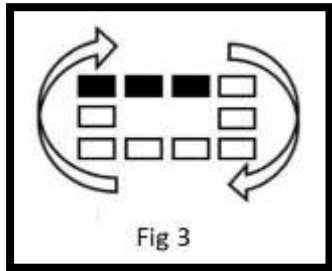

1. Switch off the mains supply from the main supply plug socket.
2. Follow removal of Burner Tray (1 – 13).
3. With the Tray upside down, remove the two off M3 nuts and washers.
4. Disconnect the cable connections from the LED strip Assembly.
5. Replace and re-assemble in reverse order.



### Replacement Handset

Follow the guide stipulated on page 11 of the users instructions "Changing the handset batteries" to load the batteries into the new handset.

The replacement handset will need to be paired again to the ECU unit.

Press and hold  (approx. 5 seconds) until the menu graphic Completes (see Fig 3). This will access the menu (see Fig 4). Use the selector wheel and select the "gas fire" option. Press  &  simultaneously to delete the current channel. The handset will re-load to "NO DEVICE" see Fig 4) screen.

### Pairing Handset

- Press eye button to wake handset
- Press & hold star button till menu is displayed – wait for box to fill
- Use wheel to scroll to display – "gas Fire"
- If not paired select – "PAIR"
- While fire is searching disconnect the power lead from the transformer
- Reconnect the transformer (should hear a beep to confirm power reconnected)
- Fire should then be paired

If the handset not pairing try breaking the power link from the transformer – then get the handset to pairing stage and then reconnect the transformer

**When ordering parts quote ` INFINITY 800HD BF UBL ` and the serial number of the fire, which can be found on the data badge on bottom left hand side of fire. (Refer to cleaning instructions for trim removal.**

**FAULT FINDING CHARTS**

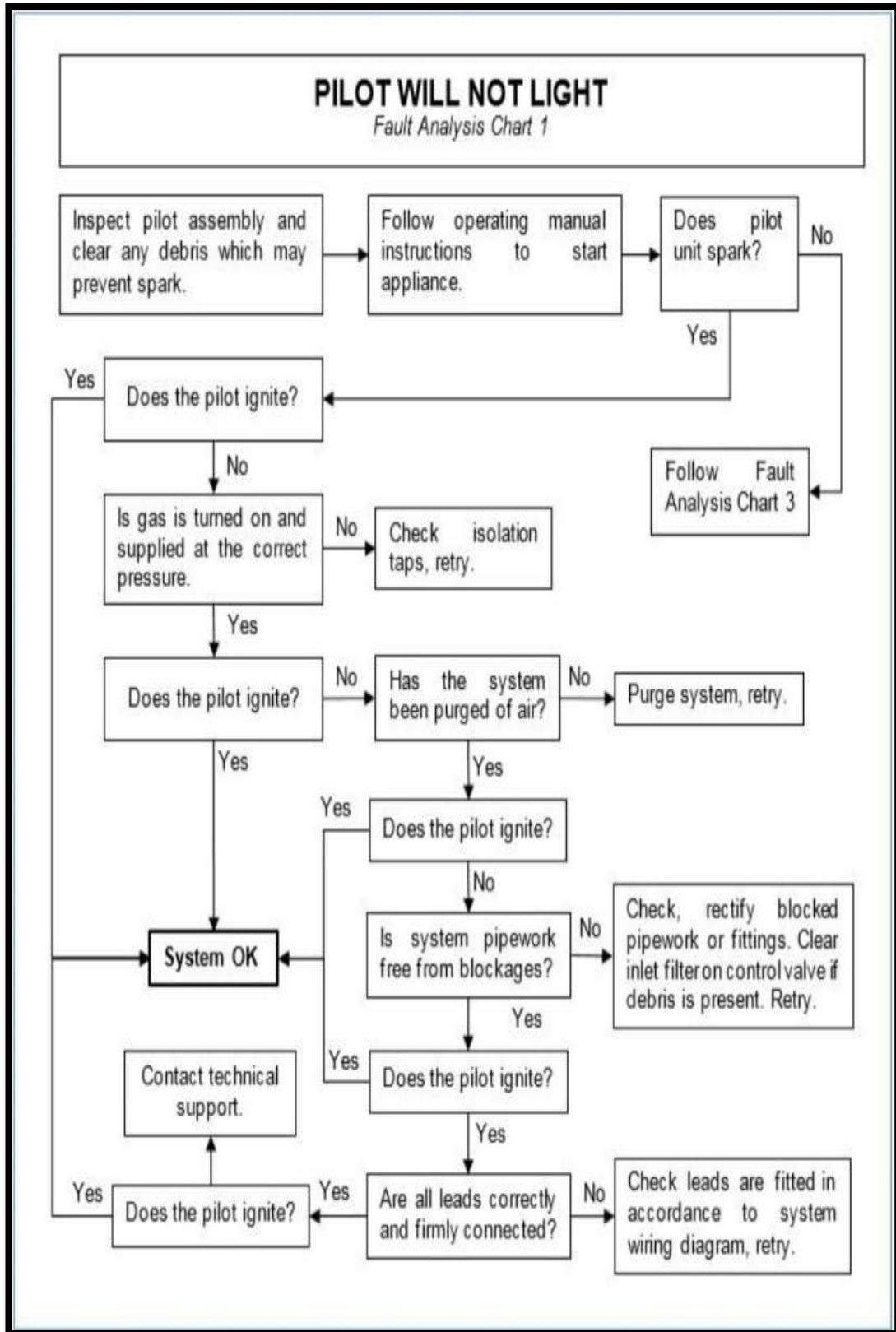



**FAULT FINDING CHARTS**

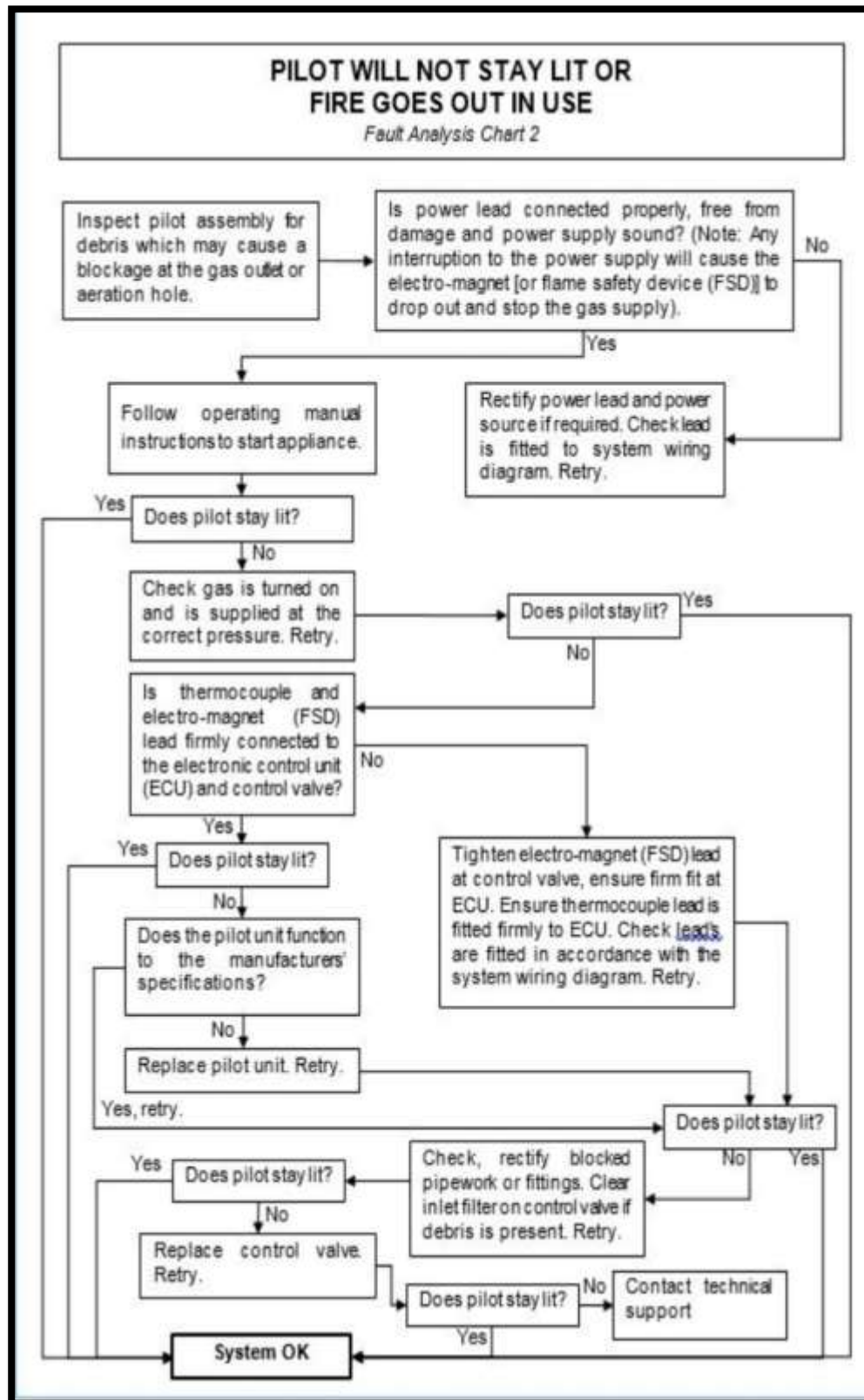

**FAULT FINDING CHARTS**

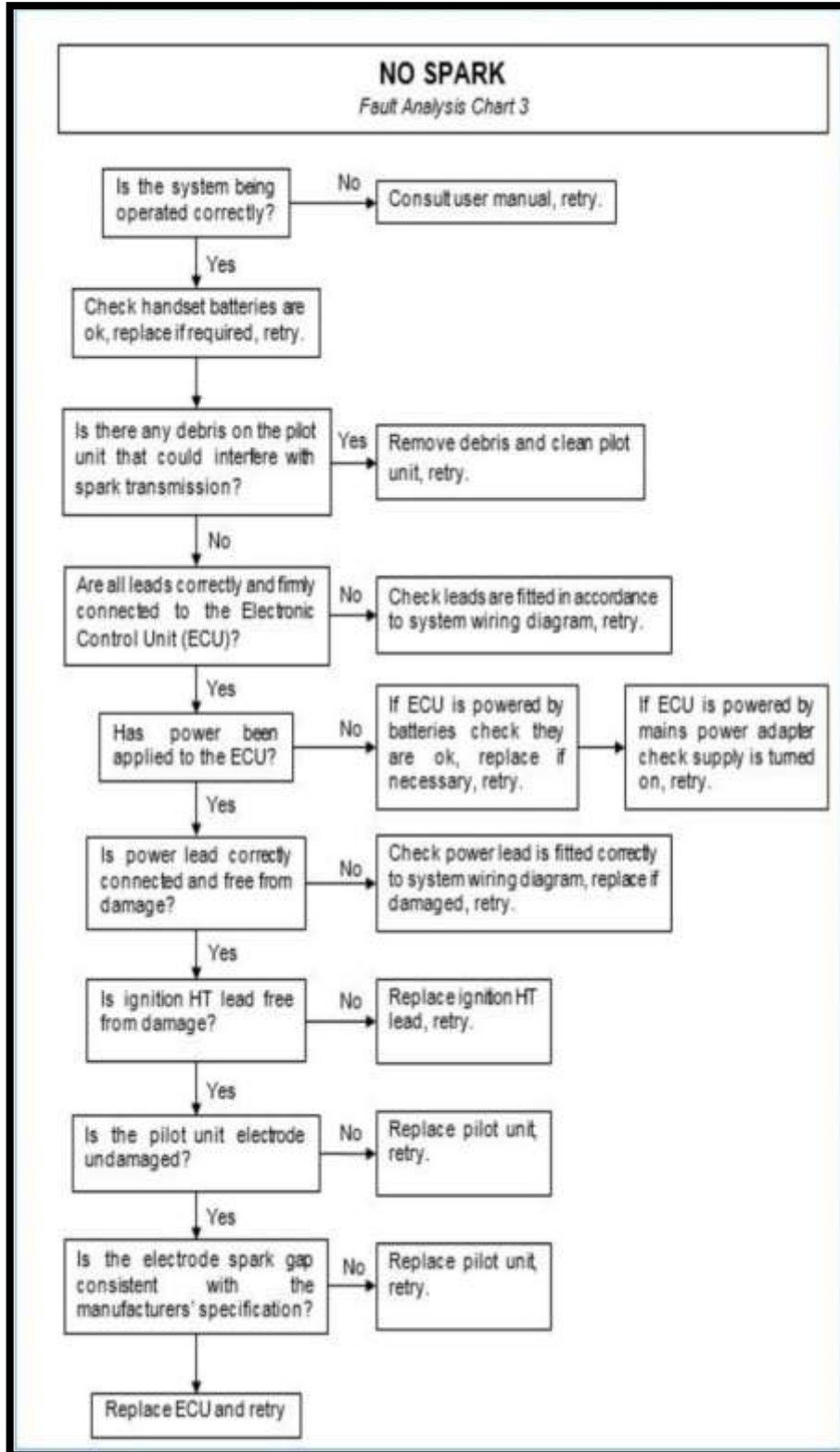

**For further information please contact the Infinity help desk on 0845 5195991 or visit our web site**

[www.CharltonandJenrick.co.uk](http://www.CharltonandJenrick.co.uk)

<b>Important</b>									
<p>For future reference we suggest you record the following details here, and keep the receipt as proof of purchase. This information may be asked for when you contact the helpdesk.            Model 800 HD B.F. with UBL</p>									
Serial No									
<p>This information can be found on the label attached to the packaging and on the data badge, which is located on the appliance.</p> <p>Retailer Name :-----</p> <p>Address :-----</p> <p>:-----</p> <p>:-----</p>									
Date of Purchase									

## Service Log Details

**It is essential that your gas fire is serviced regularly and that the appropriate Service Interval Record is completed. Service Provider**

Before completing the appropriate Service Record below, please ensure you have carried out the service as described in the manufacturer's instructions. Always use the manufacturer's specified spare part when replacing controls.

<b>SERVICE 01</b>	Date:
Engineer name:	
Company name:	
Telephone No:	
Gas safe register No:	
Comments:	
Signature	

<b>SERVICE 02</b>	Date:
Engineer name:	
Company name:	
Telephone No:	
Gas safe register No:	
Comments:	
Signature	

<b>SERVICE 03</b>	Date:
Engineer name:	
Company name:	
Telephone No:	
Gas safe register No:	
Comments:	
Signature	

<b>SERVICE 04</b>	Date:
Engineer name:	
Company name:	
Telephone No:	
Gas safe register No:	
Comments:	
Signature	

<b>SERVICE 05</b>	Date:
Engineer name:	
Company name:	
Telephone No:	
Gas safe register No:	
Comments:	
Signature	

**Register your appliance online today to activate your warranty**



## BALANCED FLUE GAS FIRE COMMISSIONING CHECKLIST

This Commissioning Checklist is to be completed in full by the competent person who commissioned the gas fire as a means of demonstrating compliance with the appropriate Building Regulations and then handed to the customer to keep for future reference.

Failure to install and commission according to the manufacturer's instructions and complete this Benchmark Commissioning Checklist will invalidate the warranty. This does not affect the customer's statutory rights. **PLEASE COMPLETE IN BLOCK CAPITALS.**

Customer name:										Telephone number:									
Address:																			
Gas Fire make and model:																			
Installation location: i.e living/dining room.																			
Gas Fire serial number:																			
Commissioned by (PRINT NAME):										Gas Safe register number:									
Company name:										Telephone number:									
Company address:																			
										Commissioning date:									
Building Regulations Notification Number (if applicable):																			

Site Requirements	Yes	N/A
Is the flue terminal sited and fitted as per the manufacturer's instructions?		
Has a terminal guard been fitted?		
<b>Hearth Requirements- where fitted</b>		
Is the hearth constructed from non -combustible material?		
Is the hearth a minimum of 12mm thick with a minimum floor to top surface of 50mm?(BS5871) or as per manufacturer's instructions?		
Is the hearth for open fronted fires a minimum of 760mm wide and has 300mm projecting from the fire opening (BS6871) or to manufacturer's instructions?		
Mounting height (where applicable) has the fire been installed to the correct mounting height- as per manufacturer's instructions?		
<b>Firebox and Fuel Bed</b>		
Has the fuel bed, coals, logs, pebbles etc. been fitted to manufacturer's instructions?		
<b>Gas Supply</b>		
Has an isolation valve inlet elbow been fitted for servicing?		
Has the gas supply been thoroughly purged prior to connection to remove any debris?		
Has a gas tightness test been completed prior to breaking into the gas supply and following completion of installation?(IGEM/UP/1B)		
Has the correct gas type been chosen as per manufacturer's instructions?		
Record burner gas pressure reading? If only the supply pressure is available a gas rate must be undertaken.(GSIUR REG26/9C)		
Record dynamic inlet gas pressure (working pressure) reading (all gas appliances running)		
<b>Installation</b>		
Has the gas fire/convector heater been installed and commissioned in accordance with manufacturer's instructions?		
Has the gas fire/convector heater been installed with the correct clearance to combustible materials, service and general clearances adhered to as per manufacturer's instructions?		
The operation of the fire/convector heater and controls have been demonstrated and understood by the customer, including replacement of batteries?		
The manufacturer's literature, including Benchmark Checklist and Service record has been explained and left with the customer?		
Has the appliance been registered with the Local Authority, as detailed on the Gas Safe web site and is a legal requirement and forms part of the warranty?		
Commissioning Engineer's Signature		
Customer's Signature (To confirm satisfactory demonstration and receipt of manufacturer's literature)		

\*All installations in England and Wales must be notified to be Local Authority Building Control (LABC) either directly or through a Competent Persons Scheme. A Building Regulations Compliance Certificate will then be issued to the customer







## Register Your 12 Month Warranty with Us Today

To register your appliance at [www.charltonandjenrick.co.uk/warranty](http://www.charltonandjenrick.co.uk/warranty).

---

### Installer Details

Name \_\_\_\_\_  
Company name \_\_\_\_\_  
Gas safe number \_\_\_\_\_  
Date of installation \_\_\_\_\_

---

### Your Details

Name \_\_\_\_\_  
Address \_\_\_\_\_  
\_\_\_\_\_  
\_\_\_\_\_  
Post Code \_\_\_\_\_ Telephone No \_\_\_\_\_

---

### Product Details

Model : 800HD B.F. with UBL Serial No \_\_\_\_\_  
Date Of Purchase \_\_\_\_\_

This information can be found on the label attached to the packaging and on the data badge.

---

Where did you purchase this product :

Name \_\_\_\_\_  
Address \_\_\_\_\_  
\_\_\_\_\_  
\_\_\_\_\_

Post Code \_\_\_\_\_ Telephone No \_\_\_\_\_





Product ID Label	A-0829 – Glass liners A-0834 – Red Brick Liners A-0835 – Vermiculite Liners	Serial No Prefix	TN (NG)
Data Badge			
Burner Tray / Box Assembly			
Air Test Completed			
Warning Label (1409)			
Grommet (1406)			
Glass Panel			
Silicone Sealing Strip (4818) x 2			
800 BF Log Set			
Fireplace Outer Frame			
Fireplace Inner Frame			
Mains Lead Fitted			
"C " Cell Battery Holder (5775)			
"AAA" Batteries ( 4 )			
Remote Control Hand Set (7144)			
Handset Holder			
9v Transformer			
Bag Of Fixings			
7mm Spinner (5435)			
Embaglow (6844)			
Snorkel Flue Assembly ( <b>packed in separate carton</b> )			
Owners Book			
Inspector			
Serial Number			